



[CITY OF]
OTTUMWA

TENTATIVE AGENDA
OTTUMWA CITY COUNCIL

REGULAR MEETING NO. 1
Bridge View Center, 102 Church St.

January 2, 2024
5:30 O'Clock P.M.

PLEDGE OF ALLEGIANCE

Judge Daily – Keith Caviness Council Seat – effective January 2, 2024.

A. ROLL CALL: Council Member Galloway, Hoffman, McAntire, Caviness and Mayor Johnson.
Pope Vacant Council Seat

City Council confirm appointment of Cyan Bossou to fill Pope Vacant Council Seat.

Judge Daily – Cyan Bossou Council Seat – effective January 2, 2024.

A. ROLL CALL: Council Member Galloway, Hoffman, McAntire, Caviness, Bossou and Mayor Johnson.

B. CONSENT AGENDA:

1. Minutes from Special Meeting No. 32 on December 12, 2023, Special Meeting No. 33 on December 18, 2023, Regular Meeting No. 34 on December 19, 2023 and Special Meeting No. 35 on December 21, 2023 as presented.
2. Recognize the appointment of Council Member Galloway to serve as Mayor Pro Tem for calendar year 2024.
3. Civil Service Eligibility Lists for December 27, 2023: Engineering Aide Entrance.
4. Approving the purchase of 2024 2 ½ Ton Truck from O'Halloran for the Streets Department, totaling \$221,971.
5. Resolution No. 1-2024, setting January 16, 2024 as the date of a public hearing on the consideration of a ten-year municipal lease and operating agreement between the City of Ottumwa and A.A.W. Golf Group, LLC.
6. Resolution No. 4-2024, approving the contract, bonds, and certificate of insurance for the Elm Street & Fellows Avenue Reconstruction Project.
7. Resolution No. 9-2024, setting January 16, 2024 as the date of a public hearing on the Proposal to Renew the Downtown Ottumwa Self-Supported Municipal Improvement District (SSMID).
8. Beer and/or liquor applications for: Iowa Liquor & Tobacco, 1021 E. Main St.; Dollar General Store #7179, 721 N. Quincy Ave.; all applications pending final inspections.

C. APPROVAL OF AGENDA

D. ADMINISTRATORS REPORT TO COUNCIL AND CITIZENS:

1. Status of Financial Reporting of City Funds – Jessica Kinser, Interim Finance Director.

All items on this agenda are subject to discussion and/or action.

E. IDENTIFICATION OF CITIZENS DESIRING TO COMMENT ON AGENDA ITEMS:

(When called upon by the Mayor, step to the microphone; state their name, address and agenda item to be addressed. The Mayor will invite you to address the Council when that topic is being discussed. Remarks will be limited to **three minutes or less**. The City Clerk shall keep the time and notify the Mayor when the allotted time limit has been reached. Comments are to be directly germane to the agenda item being discussed; if not directly germane as determined by the Mayor will be ruled out of order.)

F. PUBLIC HEARING:

G. ORDINANCES:

H. DEPARTMENTAL, BOARD, OR COMMISSION RECOMMENDATIONS/REPORTS:

1. Report on Bird E-Scooter Program

RECOMMENDATION: Staff Seeks direction from Council on possible renewal of e-scooter program with Bird.

2. New Fire Apparatus for the Fire Department.

RECOMMENDATION: authorize the purchase of a New Fire Apparatus from Sutphen Corporation in the amount of \$869,400.34.

I. RESOLUTIONS:

1. Resolution No. 2-2024, establishing Electrical Permit Fees for Wiring Statement Inspections in the City of Ottumwa.

RECOMMENDATION: Pass and adopt Resolution No. 2-2024.

2. Resolution No. 3-2024, awarding the contract for the Blake's Branch Phase 8, Division II, Sewer Separation project to J&K Contracting, LLC, of Urbandale, Iowa, in the amount of \$5,716,345.

RECOMMENDATION: Pass and adopt Resolution No. 3-2024.

3. Resolution No. 5-2024, accept the Proposed Extension from Ahlers and Cooney, PC for the Provision of General Legal Services.

RECOMMENDATION: Pass and adopt Resolution No. 5-2024.

4. Resolution No. 6-2024, removing a special assessment applied to 121 South Iowa Avenue on Resolution No. 41-2023.

RECOMMENDATION: Pass and adopt Resolution No. 6-2024.

5. Resolution No. 7-2024, authorizing a release and satisfaction for judgements against the property located at 130 South Iowa Avenue.

RECOMMENDATION: Pass and adopt Resolution No. 7-2024.

6. Resolution No. 8-2024, approving and authorizing execution of an agreement for private development and off-site improvements by and between the City of Ottumwa and Christner Properties, LLC.

RECOMMENDATION: Pass and adopt Resolution No. 8-2024.

J. PUBLIC FORUM:

The Mayor will request comments from the public on topics of city business or operations other than those listed on this agenda. Comments shall not be personalized and limited to three minutes or less. Comments not directly applicable to operations, inappropriate, or an improper utilization of meeting time, as determined by the Mayor, will be ruled out of order. When called upon by the Mayor, step to the microphone; give your name, address and topic on which to address the Council. The Council is not likely to take any action on your comments due to requirements of the Open Meetings Law. Pertinent questions, comments or suggestions may be referred to the appropriate department, city administrator or legal counsel for response, if relevant.

K. MAYOR/CITY COUNCIL REPORT AND/OR COMMUNICATIONS

ADJOURN

***** It is the goal of the City of Ottumwa that all City Council public meetings are accessible to people with disabilities. If you need assistance in participating in City Council meetings due to a disability as defined under the ADA, please call the City Clerk's Office at (641) 683-0621 at least one (1) business day prior to the scheduled meeting to request an accommodation. *****



[CITY OF]
O T T U M W A

FAX COVER SHEET

City of Ottumwa

DATE: 12/29/2023 TIME: 12:00 PM NO. OF PAGES 4
(Including Cover Sheet)

TO: News Media CO: _____

FAX NO: _____

FROM: Christina Reinhard

FAX NO: 641-683-0613 PHONE NO: 641-683-0620

MEMO: Tentative Agenda for the Regular City Council Meeting #1 to be held on 1/2/2024 at 5:30 P.M. at Bridge View Center.

 FAX MULTI TX REPORT

JOB NO. 4172
 DEPT. ID 4717
 PGS. 4

TX INCOMPLETE -----
 TRANSACTION OK 916606271885
 916416823269
 ERROR 916416847834
 916416828482

KTVO
 Ottumwa Waterworks
 Ottumwa Courier
 Tom FM



CITY OF
 OTTUMWA

FAX COVER SHEET

City of Ottumwa

DATE: 12/29/2023 TIME: 12:00 PM NO. OF PAGES 4
 (Including Cover Sheet)

TO: News Media CO: _____

FAX NO: _____

FROM: Christina Reinhard

FAX NO: 641-683-0613 PHONE NO: 641-683-0620

MEMO: Tentative Agenda for the Regular City Council Meeting #1 to be held on 1/2/2024 at 5:30 P.M. at Bridge View Center.

TX REPORT

JOB NO. 4172
DEPT. ID 4717
ST. TIME 12/29 11:57
SHEETS 4
FILE NAME

TX INCOMPLETE -----
TRANSACTION OK 916606271885
916416823269
ERROR 916416847834
916416828482

KTVO
Ottumwa Waterworks
Ottumwa Courier
Tom FM



CITY OF
OTTUMWA

FAX COVER SHEET

City of Ottumwa

DATE: 12/29/2023 TIME: 12:00 PM NO. OF PAGES 4
(Including Cover Sheet)

TO: News Media CO: _____

FAX NO: _____

FROM: Christina Reinhard

FAX NO: 641-683-0613 PHONE NO: 641-683-0620

MEMO: Tentative Agenda for the Regular City Council Meeting #1 to be held on 1/2/2024 at 5:30 P.M. at Bridge View Center.

OTTUMWA CITY COUNCIL MINUTES Item No. B.-1.

SPECIAL MEETING NO. 32
Bridge View Center, 102 Church Street

December 12, 2023
5:00 O'Clock P.M.

The meeting was called to order at 5:00 P.M.

Present were Council Member Galloway, Hoffman, McAntire, Roe and Mayor Johnson.
Council Member Pope was absent.

Roe moved, seconded by Galloway to approve the agenda as presented. Motion carried 4-1. Absent: Pope.

City Admin. Rath introduced three candidates who submitted proposals to the Cedar Creek Golf Course Operations RFP. Each will have ten mins. to present; followed by a set of eight questions to be answered within fifteen mins. Additional questions may be asked of council after all have presented.

Champion Bowl of Ottumwa Ltd, DBA DTech Enterprises – Doug Techel presented.

Highlights: Successful business owner in Ottumwa for over 20 yrs.; surround yourself with smart people; treat customers and employees with respect; never settle for mediocracy; fundraisers will continue; price structure remains the same, with a slight increase the following year; all key positions will be asked to remain on staff; I want to keep all of the scheduled tournaments – this is a community asset that brings in people from all areas; Greg has done a fantastic job with the course; the golf course is a park and as parks go, you need plenty of water in storage and tree maintenance; have been in contact with IHCC possibilities of hosting collegiate events; I think it's very important to keep it local.

A.A.W. Golf Group, LLC – Adam Wilson presented.

Highlights: I am the ideal candidate; 15 yrs. of personal experience working under my Dad (Greg Wilson) at Cedar Creek; creating and running new tournaments and events; proven track record of running the course efficiently; Cedar Creek is very playable from senior citizens to families with younger children; the customers at Cedar Creek are more than happy with the way we have operated things for the past two decades; relationships formed with customers make it easy to be here; my proposal is competitive yet fair; I want to build upon the legacy already established at Cedar Creek; maintain the beauty and integrity of the course; continue with charitable events for the community; I know the people, I know the course, I have the public support and I think they want me to be here.

Maxim Golf Solutions, LLC – Bryan Minnis, CEO, presented.

Highlights: Maxim was formed in 2011 to meet the needs of golf course owners and operators who could benefit from the expertise of industry professionals offering affordable services and sensible solutions to the challenges faced in today's golf economy. Missouri based Company; manage a number of properties throughout Missouri, Kansas, Arkansas, Utah; staff includes professionals in every facet of club operations including golf shop operations, food & beverage, grounds & maintenance, sales & marketing, membership, training, clubhouse mgmt. and technology; Our mission is to provide the highest level of quality golf, recreational, and social experiences possible to our Members & Patrons. We know the course has been treated well and we want to continue to provide an excellent product; golf appears to be an anchor amenity for the City of Ottumwa and we would look at trying to draw outside visitation to the course.

Q&A with Council; a few highlights

Confirm that the course will remain open to the public and not become "semi-private" with increased fee structures; Maintain the integrity of the course and keeping it accessible to all levels of golfers (senior citizens, families, children, handicap); Continued work with the leagues in place and possible growth for

more to be formed; Concern of keeping business practices local (purchasing merchandise, catering, etc.); Council wants to see passion for Ottumwa; What are some things that will move the course to the next level?; Pricing structures vary; are they sustainable?

Roe moved, seconded by Galloway to table Resolution No. 205-2023, Awarding of RFP-Cedar Creek Golf Course Operations, until the next mtg. Roe stated he has a solid reason for tabling this item; we have been through an entire election cycle with much criticism as a council that we make decisions without a full council present, and yet again tonight we are short one council person. I think we run the risk of damaging relationships with one or multiple folks up here tonight should we disagree; table this item until the entire city council is here to make a decision and discuss this topic at length. Numerous people from the audience voiced their concerns; time is of the essence, can you guarantee that you will have a full council in attendance Tuesday? It was explained that if council were to vote tonight, and it ends in a tie vote (2-2), nobody will be awarded the contract. Council person Pope's vote counts as a No when she is absent. Motion carried 4-1. Absent: Pope.

There being no further discussion, Galloway moved, seconded by Hoffman that the mtg. adjourn. Motion carried 4-1. Absent: Pope.

Adjournment was at 7:23 P.M.

CITY OF OTTUMWA, IOWA

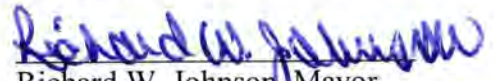
Richard W. Johnson, Mayor

ATTEST:

Christina Reinhard, IaCMC, City Clerk

Published in the Ottumwa Courier on 12/21/2023.

OTTUMWA CITY COUNCIL MINUTES

SPECIAL MEETING NO. 33
Bridge View Center, 102 Church Street

December 18, 2023
5:30 O'Clock P.M.

The meeting was called to order at 5:30 P.M.

Present were Council Member Hoffman, McAntire, Pope, Roe, Galloway and Mayor Johnson.

Pope began by apologizing to the citizens of Ottumwa for her unforeseen absences over the past two years; felt threatened and attacked publically with a petition requesting her resignation. Thank-you for the opportunity to serve this community. I will remain committed to the well-being of Ottumwa, but as of today, I will be stepping down as a city council member.

Roe stated it was an appropriate thing for Pope to do and it takes a lot of courage to say what she did.

McAntire moved, seconded by Pope to approve agenda as presented. All ayes.

Galloway moved, seconded by Roe to remove Res. No. 205-2023 from the table. All ayes.

Galloway moved, seconded by Hoffman that Res. No. 205-2023, Awarding RFP – Cedar Creek Golf Course Operations, to Adam Wilson with A.A.W. Golf Group, LLC, of Ottumwa, Iowa, be passed and adopted. Galloway stated, both Adam and his father Greg Wilson, have made valuable contributions to the course and have the vision and potential to grow it even further; emphasis on the community, communication and service and growth was impressive during his presentation. Hoffman agreed and stated it would be hard, in his opinion, not to choose who is currently there, providing the service now. All ayes.

Mitch Niner discussed the golf course decision made by council fifteen years prior; and how he admits he voted wrong.

Mayor Johnson inquired if anyone from the audience wished to address an item not on the agenda. Kinyotta Pope voiced her concerns on the display of bullying by adults within the community against council person Pope. Everyone should be treated fairly; feels that this is an attack against her character. If council was really about change, they would not be trying to force someone to resign.

There being no further business, McAntire moved, seconded by Roe that the mtg. adjourn. All ayes.

Adjournment was at 5:47 P.M.

ATTEST:



Christina Reinhard, IaCMC, City Clerk

CITY OF OTTUMWA, IOWA

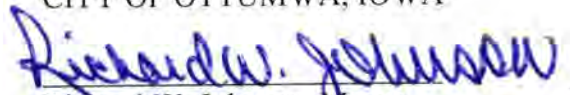
Richard W. Johnson, Mayor

Published in the Ottumwa Courier on 12/28/2023.

OTTUMWA CITY COUNCIL MINUTES

REGULAR MEETING NO. 34
Bridge View Center, 102 Church St.

December 19, 2023
5:30 O'Clock P.M.

The meeting was called to order at 5:30 P.M.

Present were Council Member McAntire, Roe, Galloway, Hoffman and Mayor Johnson.
Pope Council Seat Vacant.

Roe moved, seconded by Galloway to approve consent agenda items: Mins. from Regular Mtg. No. 31 on Dec. 5, 2023 as presented; Ack. June 2023 reconciliation, July 2023 and August 2023 financial stmts. and pymt. of bills as submitted by Finance Dept.; Civil Service Elig. Lists for Dec. 6, 2023: I.T. Tech. Ent. and Firefighter Ent.; Res. No. 212-2023, approving contract, bonds, and cert. of ins. for Greater Ottumwa Park Soccer Complex Project; Res. No. 219-2023, approving contract, bonds, and cert. of ins. for Richmond Ave. Pump Station Improvements Project; Res. No. 226-2023, setting Jan. 2, 2024 as date of public hearing on Proposal to Renew Downtown Ottumwa Self-Supported Municipal Improvement District (SSMID); Beer and/or liquor applications for: La Guadalupana, 301 Church St.; El Rancho Grande, 232 E. Main; all applications pending final inspections. Motion carried 4-1.

Galloway moved, seconded by McAntire to approve Agenda as presented. Motion carried 4-1.

City Admin. Rath reported council will hold special mtg. Thursday, Dec. 21, 2023 at 4:00 P.M. to discuss and determine how to fill vacancy left by Pope's resignation.

Interim Finance Dir. Kinser updated council on finance items. Proof of progress that has been made so far; closed out FY23; published AFR on 12/9/2023; July & Aug have been reconciled.

Mayor Johnson inquired if anyone from the audience wished to address an item on the agenda. There were none.

This was the time, place and date set for a public hearing on proposal to lease certain real property at Ottumwa Reg. Airport to The American Bottling Company, Inc. Dir. of Airport Operations Wheaton reported five yr. lease (2024-2028) with option to extend for two more five yr. terms; this parcel is used for truck parking; \$3,499 per yr. No objections rec'd. McAntire moved, seconded by Galloway to close public hearing. Motion carried 4-1.

Roe moved, seconded by McAntire that Res. No. 202-2023, approving and authorizing lease of certain real property at Ottumwa Reg. Airport to The American Bottling Company, Inc., be passed and adopted. Motion carried 4-1.

This was the time, place and date set for a public hearing on proposal to lease certain real property at Ottumwa Reg. Airport to The American Bottling Company. Wheaton reported five yr. lease (2024-2028) with option to extend for two more five yr. terms; this parcel is used for their water treatment facility; \$3,478 per yr. No objections rec'd. Galloway moved, seconded by Hoffman to close public hearing. Motion carried 4-1.

Hoffman moved, seconded by Galloway that Res. No. 203-2023, approving and authorizing lease of certain real property at Ottumwa Reg. Airport to The American Bottling Company, be passed and adopted. Motion carried 4-1.

This was the time, place and date set for a public hearing approving Support and Financial Commitment for Main St. Ottumwa Program for calendar years 2024-2027. Rath reported. No objections rec'd. Roe moved, seconded by Galloway to close public hearing. Motion carried 4-1.

Hoffman moved, seconded by McAntire that Res. No. 204-2023, approving Support and Financial Commitment for Main St. Ottumwa Program for calendar yrs. 2024-2027, be passed and adopted. Motion carried 4-1.

This was the time, place and date set for a public hearing on the disposal of City owned property at 129 N. McLean St., Ottumwa, Wapello County, IA, to JMH, Ent., LLC. Comm. Development Dir. Simonson reported. No objections rec'd. McAntire moved, seconded by Hoffman to close public hearing. Motion carried 4-1.

McAntire moved, seconded by Roe that Res. No. 209-2023, approving and authorizing conveyance of certain real property 129 N. McLean St., Ottumwa, Wapello County, IA to JMH, Ent., LLC for \$500, be passed and adopted. Motion carried 4-1.

This was the time, place and date set for a public hearing on the disposal of City owned vacant lot No. 214 on Morris St., Ottumwa, Wapello County, IA to Roland and Linda Davis. Simonson reported. No objections rec'd. Galloway moved, seconded by Hoffman to close public hearing. Motion carried 4-1.

Roe moved, seconded by McAntire that Res. No. 210-2023, approving and authorizing conveyance of certain real property vacant lot No. 214 on Morris St., Ottumwa, Wapello County, IA to Roland and Linda Davis for \$250, be passed and adopted. Motion carried 4-1.

McAntire moved, seconded by Roe to pass the first consideration of Ord. No. 3220-2023, amending the Municipal Code of the City of Ottumwa, IA, by Repealing and Replacing Ch. 1, Art. IV, IA Income Offset Program, for the Purpose of Complying with the Revised State Program. Motion carried 4-1.

Galloway moved, seconded by McAntire to waive the second and third considerations, pass and adopt Ord. No. 3220-2023. Motion carried 4-1.

Rath presented FY2023 Annual City Street Finance Report.

McAntire moved, seconded by Roe to approve budgeted repairs totaling \$52,773.30 for Belt Filter Press Repairs for WPCF. Motion carried 4-1.

Roe moved, seconded by McAntire that Res. No. 211-2023, authorizing withdrawal of interest earned from City of Ottumwa Iowa Public Agency Investment Trust (IPAIT) for FY24 and 25, be passed and adopted. Kinser reported. Motion carried 4-1.

Galloway moved, seconded by McAntire that Res. No. 213-2023, awarding contracts for Asbestos Abatement (Torres Const. \$4,000) and Demolition (Don Jones \$7,200) of the condemned property at 206 E. Finley, be passed and adopted. Motion carried 4-1.

Roe moved, seconded by McAntire that Res. No. 214-2023, awarding contracts for Asbestos Abatement (Torres Const. \$1,200) and Demolition (Don Jones \$5,000) of the condemned property at 556 S. Ward, be passed and adopted. Motion carried 4-1.

Galloway moved, seconded by Hoffman that Res. No. 215-2023, approving final plat of Christner's

Second Subdivision in the City of Ottumwa, Wapello County, IA and rescinding Res. No. 99-2023, be passed and adopted. Motion carried 4-1.

McAntire moved, seconded by Hoffman that Res. No. 216-2023, approving updates to Personnel Policy, be passed and adopted. Motion carried 4-1.

Galloway moved, seconded by McAntire that Res. No. 217-2023, approving transfer of funds through Sept. 2023 for FY23 and those for FY24 budget as processed by Finance Dept., be passed and adopted. Motion carried 4-1.

Roe moved seconded by Hoffman that Res. No. 218-2023, authorizing pymt. of certain expenses without prior City Council Auth., be passed and adopted. Motion carried 4-1.

Roe moved, seconded by Galloway that Res. No. 220-2023, approving CO# 8, accepting work as final and complete and approving final pay req. for Blake's Branch Sewer Separation Ph. 8, Div. 1 Project after 30 days, be passed and adopted. PW Dir/City Engineer Burgmeier reported CO#8 decreases contract by \$258,506.19; new contract sum \$12,163,017.22. Motion carried 4-1.

Galloway moved, seconded by McAntire that Res. No. 221-2023, approving CO# 3, accepting work as final and complete and approving final pay req. for Blake's Branch Sewer Separation Ph. 8, Div. 1, East of Iowa Ave. Project after 30 days, be passed and adopted. Burgmeier reported CO#3 decreases contract by \$21,778.65; new contract sum \$3,141,036.42. Motion carried 4-1.

Galloway moved, seconded by McAntire that Res. No. 222-2023, awarding contract for Elm St. and Fellows Ave. Reconstruction Project to Jones Contracting Corp. of West Point, IA for \$998,554, be passed and adopted. Burgmeier reported six bids rec'd. Motion carried 4-1.

Roe moved, seconded by Galloway that Res. No. 224-2023, approving CO# 1 and accepting work as final and complete and approving Final Pay Req. for 2023 RFP No. 2, James St. Sewer Repair Project, be passed and adopted. Burgmeier reported CO#1 increased contract by \$5,000; new contract sum \$29,550. Motion carried 4-1.

McAntire moved, seconded by Hoffman that Res. No. 225-2023, consideration of Pilot Youth Government Program, be passed and adopted. Galloway along with Kolby Streeby, Ottumwa Com. School Dist. reported. Motion carried 4-1.

McAntire moved, seconded by Hoffman that Res. No. 227-2023, providing financial support of Area 15 Reg. Planning Comm. for FY24 (total amt. \$13,530.37), be passed and adopted. Galloway stated she is disappointed that no one from RPC is in attendance; requests an update from them in the near future. Motion carried 4-1.

Roe moved, seconded by Galloway that Res. No. 228-2023, providing financial support of Area 15 Reg. Planning Affiliation (RPA 15) for \$6,291 for FY24, be passed and adopted. Motion carried 4-1.

McAntire moved, seconded by Galloway that Res. No. 229-2023, opposing Alliant Energy's Electric Rate Increase, be passed and adopted. Mayor Johnson reported. Motion carried 4-1.

Mayor Johnson inquired if anyone from the audience wished to address an item not on the agenda. There were none.

Roe thanked everyone for allowing him to serve on council for the past eight yrs.

There being no further business, McAntire moved, seconded by Roe that the mtg. adjourn. Motion carried 3-2. Ayes: McAntire, Galloway, Hoffman. Nays: Roe. Vacant: Pope.

Adjournment was at 7:04 P.M.

CITY OF OTTUMWA, IOWA

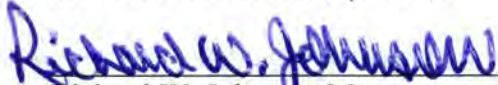
Richard W. Johnson, Mayor

ATTEST:

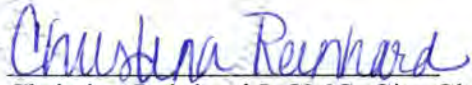

Christina Reinhard IaCMC, City Clerk

Published in the Ottumwa Courier on 12/30/2023.

OTTUMWA CITY COUNCIL MINUTES

SPECIAL MEETING NO. 35
Room 8B – Depot Conference Room

December 21, 2023
4:00 O'Clock P.M.

The meeting was called to order at 4:00 P.M.

Sherrie Jones is acting City Clerk for this mtg.

Present were Council Member Roe, Galloway, Hoffman, McAntire and Mayor Johnson.
Pope Vacant Council Seat.

Hoffman moved, seconded by Galloway to approve agenda as presented. Motion carried 4-1.

Roe moved, seconded by Galloway to appoint someone to fill vacant council seat according to the last election results (from November 7, 2023), which would be Cyan Bossou, as the next highest vote tally. Motion carried 4-1.

City Admin. Rath reported the notice of city council vacancy will be published, giving citizens fourteen days to file a petition requiring that the vacancy be filled by a special election. The petition must contain a minimum of 450 signatures (which is 15% of the voters who voted at the last regular election at which the office was on the ballot).

Mayor Johnson inquired if anyone from the audience wished to address any item not on the agenda. Tom Lazio stated he would like the City to go back to streaming the council mtgs. live so citizens can watch in real time.

There being no further business, McAntire moved, seconded by Galloway that the mtg. adjourn. Motion carried 3-2. Vote Ayes: Galloway, Hoffman, McAntire. Nays: Roe. Vacant: Pope.

Adjournment was at 4:35 P.M.

CITY OF OTTUMWA, IOWA

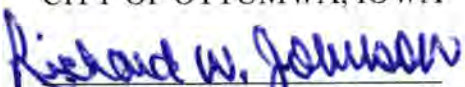
Richard W. Johnson, Mayor

ATTEST:

Sherrie Jones, Acting City Clerk

Published in the Ottumwa Courier on 12/30/2023.

OTTUMWA CIVIL SERVICE COMMISSION

ENGINEERING AIDE – Entrance Eligibility List

1. Chad Ingle

Certified December 27, 2023

OTTUMWA CIVIL SERVICE COMMISSION

Ed Wilson, Chairman
Ann Youngman
Amy Gardner

rec 12-29-23 9/5A

Item No. B.-4.

CITY OF OTTUMWA

Staff Summary

**** ACTION ITEM ****

Council Meeting of: January 2, 2024

Kelly Blankenship

Prepared By

Street
Department

Phillip Burgmeier *PB*

Department Head

PJ Ret
City Administrator Approval

AGENDA TITLE: Purchase a 2024 2-1/2 Ton Truck from O'Halloran International in the amount of \$221,971.

****Public hearing required if this box is checked. ****

****The Proof of Publication for each Public Hearing must be attached to this Staff Summary. If the Proof of Publication is not attached, the item will not be placed on the agenda.****

RECOMMENDATION: Approve the purchase of a 2024 2-1/2 Ton Truck from O'Halloran International in the amount of \$221,971.

DISCUSSION: This truck will replace #130 which was purchased in February of 2014. #130 has emission system problems, hydraulics won't run the plow and spreader at the same time as well as the bell housing being replaced five times at a cost of \$3,800 each time.

The truck was evaluated on October 7, 2022 with a recommendation to replace. The Fleet Committee approved the recommendation at the December 7, 2022 meeting. Specs for a new truck were presented and approved by the Fleet Committee at the May 24, 2023 meeting. #130 will be sent to auction upon receipt of a new truck which is purchased through state bid.

Replacement cost: \$221,971

Budgeted amount: \$211,000

Source of Funds: 210 & 250

Budgeted Item: Yes

Budget Amendment Needed: No

PURCHASE ORDER FOR NEW OR USED COMMERCIAL VEHICLES



OHI-Des Moines
3311 Adventureland Dr.
Altoona, IA 50009
800-800-6503

OHI-Cherokee
1324 S. 2nd St.
Cherokee, IA 51012
712-225-2553

OHI-Carroll
21064 - 180th St.
Carroll, IA 51404
877-875-9907

OHI-Fort Dodge
1515 3rd Ave. N.W.
Fort Dodge, IA 50501
800-293-6524

Vehicles To Be Titled As Follows:

NAME City of Ottumwa
CONTACT _____
PURCHASERS _____
PHONE _____
CELL PHONE _____
EMAIL _____
ADDRESS 105 E 3rd St
CITY Ottumwa
STATE / ZIP IA/52501
COUNTY _____

The Seller, O'Halloran, hereby expressly disclaims all warranties, either express or implied, including any implied warranty of merchantability or fitness for a particular purpose, and O'Halloran, neither assumes nor authorizes any other person to assume for it any liability in connection with the sale of the vehicle(s).

CAUTION: This agreement consists of two pages. See Reverse Side for additional provisions.

QTY	YEAR	NEW USED	MAKE	MODEL	MILEAGE	VIN SERIAL NUMBER	BODY TYPE	STOCK NO.	PRICE
1		N	Intl	HV507 4x2		Per Proposal # 18287	Plow		\$112,371.00
1						Hawkeye Truck Equipment quote #25361			\$109,600.00

Delivery of this equipment to be made at _____ on or about _____ 20____

Sourcwell Contract #060920-NVS was used to price the above noted equipment.

TRADE-INS

MAKE	YEAR-MODEL	ODOMETER READING	SERIAL NUMBER	BODY TYPE	ALLOWANCE	AMT. OWING (IF ANY)	NET ALLOWANCE	OWED TO NAME:	ADDRESS CITY-STATE

PRICE DELV'D EQUIPPED	
Processing Fee	
VEHICLE PURCHASE PRICE	\$221,971.00
FEDERAL EXCISE TAX	N/A
Less trade-in allowance	N/A
Trade difference	\$221,971.00
Sales Tax	Customer
License, Title, and Misc. Fees	Customer
TOTAL CASH PRICE	\$221,971.00
Cash down with order	
Cash due on delivery	
UNPAID BAL CASH PRICE	

DISCLAIMER OF WARRANTY

IF THERE IS A MANUFACTURER'S WARRANTY ON THE VEHICLE YOU ARE BUYING, THE DEALER IS NOT A PARTY TO IT AND IT IS NOT A PART OF THIS CONTRACT. THE MANUFACTURER'S WARRANTY IS BETWEEN YOU AND THE MANUFACTURER. AS FAR AS THE DEALER IS CONCERNED, YOU UNDERSTAND THAT THE VEHICLE IS SOLD "AS IS" WITH ALL FAULTS AND THAT WE MAKE NO WARRANTY OF MERCHANTABILITY AND NO WARRANTY THAT THE VEHICLE IS FIT FOR ANY PARTICULAR PURPOSE.

You understand that this agreement (including the terms on the back) is an offer to purchase the vehicle described which will become a binding contract once the dealer has signed it. This document represents the complete agreement between you and the dealer regardless of any other oral, written or prior agreements or representations.

Iowa law requires us to give you the following notice: **You understand that liability insurance coverage which would protect you under the Iowa Motor Vehicle Financial and Safety Responsibility Act IS NOT INCLUDED in your purchase of this motor vehicle.** By signing this contract, you are certifying that you are at least 18 years old (if there are two buyers, that at least one of you is 18 years old), that you have read this contract, front and back, and agree to its terms, and that you have received a copy of it.

Accepted by O'Halloran _____

Title _____

Buyer's Signature _____

Date _____

Dealer's Signature _____

Designer's Signature _____

Date _____

PURCHASE ORDER FOR NEW OR USED COMMERCIAL VEHICLES

Contract Terms and Conditions

In this contract the words "we," "us" and "our" refer to the dealer-seller. The words "you" and "your" refer to the buyer and co-buyer, if any.

- Cash Sale.** You agree to buy the vehicle described on the front of this document for cash. This is not a credit sale and this document is not a credit document. If you obtain financing to purchase the vehicle, you will be required to sign documents which comply with applicable federal and state laws. If you obtain financing to purchase the vehicle, there will be a fee for filing the lien on the title. This fee may be paid either to the dealer or to the lending institution from which you obtain financing.
- Warranty Disclaimer.** If there is a manufacturer's warranty on the vehicle you are buying, we are not a party to it, and it is not a part of this contract. The manufacturer's warranty is between you and the manufacturer. As far as the dealer is concerned, **you understand that the vehicle is sold "as it" with all faults and that we make no warranty of merchantability and no warranty that the vehicle is fit for any particular purpose,** unless we provided you with a written warranty or service contract within 90 days of this contract. If we do so, any implied warranty will last only as long as the limited written warranty. This provision does not affect any warranties which may be provided by the vehicle manufacturer.
NEW PRODUCTS – MANUFACTURER WARRANTIES ONLY. Any warranties on any new Product(s) sold under this Order are limited only to any printed Manufacturer's warranties delivered to You with the Product(s). EXCEPT FOR ANY SUCH WARRANTIES MADE BY MANUFACTURERS, THE PRODUCT(S) ARE SOLD WITHOUT ANY OTHER WARRANTIES, EXPRESS OR IMPLIED, INCLUDING ANY IMPLIED WARRANTY OF MERCHANTABILITY OR FITNESS FOR A PARTICULAR PURPOSE, EACH OF WHICH IS EXPRESSLY DISCLAIMED.
- USED PRODUCTS – NO WARRANTIES.** All used Product(s) sold under this Order are sold on an "AS IS, WHERE IS" basis, without any warranties by us, provided that Products are sold by dealer as "Certified Pre-Owned" are subject to express written terms and conditions of our certified pre-owned program, EXCEPT FOR ANY MANUFACTURER WARRANTIES THAT MAY STILL BE IN EFFECT. ALL OTHER WARRANTIES EXPRESS OR IMPLIED, INCLUDING ANY IMPLIED WARRANTY OF MERCHANTABILITY OR FITNESS FOR A PARTICULAR PURPOSE, ARE EXPRESSLY DISCLAIMED.
- Manufacturer's Price Revision on New Vehicle.** If you are buying a new vehicle which we do not have in stock at the time you order it and if the manufacturer changes our price of the vehicle model or body type you ordered between the time we signed this contract and the time we delivered the vehicle to you, we have the right to change the price to you. However, if you do not agree to the changed price, you may cancel this contract. If you cancel the contract, we will return your trade-in to you if it has not already been sold so long as you pay for the cost of reasonable repairs and storage fees. If we have sold your trade-in, we will pay you the amount we received for the trade-in less a selling commission of 15% and any expenses which we incurred in reconditioning, repairing, insuring, storing, and selling the vehicle.
- Manufacturer's Change of the Model and body Type of New Vehicle.** If you are buying a new vehicle and if the manufacturer changes (or discontinues) the model, design, chassis, accessories, body type or parts of the vehicle which you ordered, we will have no obligation to make the same or similar change to the vehicle you ordered either before or after we deliver the vehicle to you.
- Buyer's Warranty of Title or Trade-in.** If you traded another vehicle as part of the price of the vehicle purchased, you promise that the trade-in is your property free and clear of any liens or encumbrances except as noted on the front of this contract and that all taxes and registration fees are currently paid. If we are put to any expense with respect to unpaid taxes or registration fees, you will reimburse us for those expenses and our reasonable cost for paying those expenses upon demand. If we find out that you made any misrepresentation about the trade-in, then you will pay us three times our actual damages as a result of the misrepresentation, plus our costs of collection and attorney's fees.
- Amount Due on Trade-in.** The "Trade-In Balance Owed" on the front of this contract was provided by your lienholder. If the balance is incorrect due to the fault of the lienholder, the error will be treated as a mutual mistake of fact. In other words, if you owe more money on your trade-in, you will pay us the difference, or you can rescind the contract by returning the vehicle. If you owe less, we will pay (credit) you.
- Reappraisal of Trade-in.** If you do not deliver the trade-in to us until the purchased vehicle is delivered to you, then we may reappraise the trade-in at the time that you deliver it to us and the new appraisal will determine the allowance to be made on the vehicle purchased. If the reappraisal is lower than the original appraisal, you may cancel this contract provided you do so before you obtain delivery of the purchased vehicle and surrender the trade-in.
- Your Failure or Refusal to Accept Delivery.** If you refuse or fail to accept delivery of the purchased vehicle, we may keep your cash deposit as liquidated damages. If you had a trade-in, we may sell the trade-in and keep any part of the selling price which we need to reimburse us for losses which we incurred because you did not take delivery.
- Failure or Delay of Delivery.** We are not liable for failure to deliver or delay in delivery of the purchased vehicle if the failure or delay is due, in whole or in part, to any cause beyond our control or without our fault or negligence, including delays by the manufacturer. We are not liable to you for any consequential damages, damages to property, damage for loss of use, loss of time, loss of profits, or income or any other incidental damages arising out of the sale or use of the purchased vehicle(s).
- Liability for Taxes.** The price for the Product(s) specified on the front of this Order includes reimbursement to us for federal excise taxes paid but does not include sales or use taxes or occupational taxes based on sales volume (federal, state or local) unless expressly so stated. You assume and agree to pay, unless prohibited by law any such sales or use or occupational taxes imposed on or applicable to the transaction covered by this Order, regardless of which party may have primary tax liability thereof.
- Risk of Loss; Insurance.** You shall assume all risk of loss relating to the Product(s) at the time you receive possession of the Product(s), or at the time you receive title to the Product(s) if title is conveyed before you receive possession. You shall obtain insurance for the Product(s) that will be in effect at the time you take possession of the Product(s), or at the time you receive title to the Product(s) if title is conveyed before you receive possession. We shall have no responsibility or liability related to the Product(s) after you receive either possession or title to the Product(s).
- Limitation of Damages.** You agree that in the event of any Action brought by you against us, you shall not be entitled to recover any incidental or consequential damages as defined in the Uniform Commercial Code, including but not limited to indirect or special damages, loss of income or anticipated profits, or down-time or any punitive damages.
- Dealer's Remedies.** If you fail to perform all of the terms and conditions of this contract, we may exercise any right or remedy granted by law as well as the other remedies described in this contract.
- Governing Law; Venue; Time to Commence Action.** Except to the extent that the laws of the United States may apply or otherwise control this Order the rights and obligations of the parties hereunder shall be governed by, and construed and interpreted in accordance with, the laws of the state in which we are located, without regard to conflict of law principles. The mandatory venue for any claim, litigation, civil action, or any other legal or administrative proceeding ("Action") involving any controversy or claim between or among the parties to this Order, is the state in which dealer is located. You have one (1) year from the accrual of any cause of action arising from the purchase of the Product(s) to commence an Action against us.
- Additional Documents.** You agree to sign any other documents which are required to transfer title to the trade-in vehicle or the purchased vehicle, including odometer statements and powers of attorney.
- Attorney's Fees.** If you default on this contract, you will pay us our costs and attorneys' fees and late charges in addition to our damages.
- Fees and Expenses of Actions.** In any Action, whether initiated by us or you, where you have a right, pursuant to statute, common law or otherwise to recover reasonable attorney's fees and costs in the event it prevails, you agree that we shall have the same right to recover reasonable attorney's fees and costs incurred in connection with the Action in the event we prevail.
- All equipment, accessories and tires affixed to the trade-in(s) at the time of appraisal must remain with the trade-in(s) unless specified in the agreement to the contrary.
- This agreement shall not become binding on us unless and until the finance institution has approved all terms of this contract including any time periods, if any.

Mailing Address
P.O. Box 1804
Des Moines, IA 50306
(515) 967-3300

Customer Initials _____

Prepared For:
 CITY OF OTTUMWA
 Robin Fitzsimmons
 105 E 3rd St.
 Ottumwa, IA 52501-2999
 (641)683 - 0603
 Reference ID: N/A

Presented By:
 O'HALLORAN INTERNATIONAL
 Shane Broderick
 3311 ADVENTURELAND DRIVE
 ALTOONA IA 50009 -
 (515)967-3300

Here is the pricing for a new International HV5074x2 chassis using the National Sourcewell Program that the State of Iowa has used the last several years to purchase their snow equipment contract #060920-NVS. Hawkeye Truck Equipment has provided an equipment quote for this unit. They offer two options for the equipment: 1.) Pay for the equipment when it arrives if the truck has not arrived yet, or 2.) Wait to order the equipment based on chassis delivery date, but this may cause fluctuating pricing for the equipment if pricing changes by the time the equipment is ordered. Pricing includes 5 year 100,000 mile extended engine and after treatment coverage.

\$112,371.00 International HV507 4x2
 \$109,600.00 Hawkeye Truck Equipment Quote #25361

 \$221,971.00 Total for truck and equipment

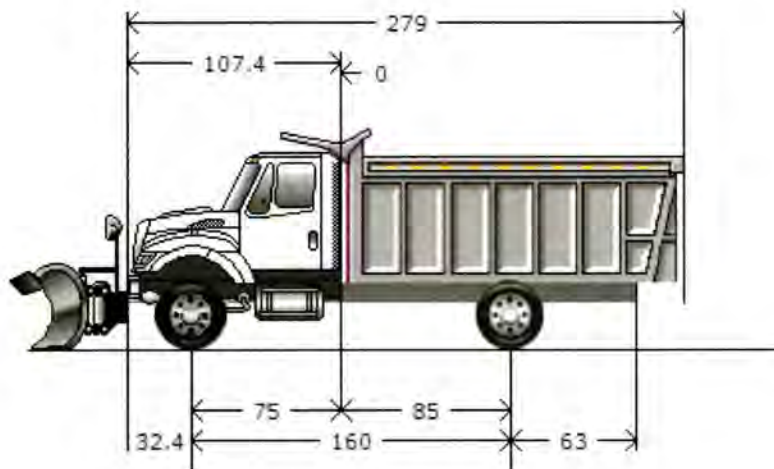

Model Profile
2025 HV507 SFA (HV507)

AXLE CONFIG:	4X2
APPLICATION:	Front Plow No Spreader
MISSION:	Requested GVWR: 36220. Calc. GVWR: 36220. Calc. GCWR: 80000
DIMENSION:	Wheelbase: 160.00, CA: 85.00, Axle to Frame: 63.00
ENGINE, DIESEL:	{Cummins L9 300} EPA 2024, 300HP @ 2200 RPM, 860 lb-ft Torque @ 1200 RPM, 2200 RPM Governed Speed, 300 Peak HP (Max)
TRANSMISSION, AUTOMATIC:	{Allison 3500 RDS} 6th Generation Controls, Wide Ratio, 6-Speed with Double Overdrive, with PTO Provision, Less Retarder, Includes Oil Level Sensor, with 80,000-lb GVW and GCW Max, On/Off Highway
CLUTCH:	Omit Item (Clutch & Control)
AXLE, FRONT NON-DRIVING:	{Meritor MFS-14-143A} Wide Track, I-Beam Type, 14,000-lb Capacity
AXLE, REAR, SINGLE:	{Meritor RS-23-160} Single Reduction, 23,000-lb Capacity, 200 Wheel Ends Gear Ratio: 5.63
CAB:	Conventional, Day Cab
TIRE, FRONT:	(2) 11R22.5 Load Range H HSR 3 (CONTINENTAL), 494 rev/mile, 75 MPH, All-Position
TIRE, REAR:	(4) 11R22.5 Load Range H HDR2+ (CONTINENTAL), 491 rev/mile, 75 MPH, Drive
SUSPENSION, REAR, SINGLE:	31,000-lb Capacity, Vari-Rate Springs, with 4500-lb Capacity Auxiliary Rubber Springs
PAINT:	Cab schematic 100WK Location 1: 9219, Winter White (Std) Chassis schematic N/A

<u>Code</u>	<u>Description</u>
HV50700	Base Chassis, Model HV507 SFA with 160.00 Wheelbase, 85.00 CA, and 63.00 Axle to Frame.

AXLE CONFIGURATION

1ANA	AXLE CONFIGURATION {Navistar} 4x2
	<u>Notes</u> : Pricing may change if axle configuration is changed.

ENGINE

12EYW	ENGINE, DIESEL {Cummins L9 300} EPA 2024, 300HP @ 2200 RPM, 860 lb-ft Torque @ 1200 RPM, 2200 RPM Governed Speed, 300 Peak HP (Max)
12VJS	EMISSION, CALENDAR YEAR {Cummins L9} EPA, OBD and GHG Certified for Calendar Year 2024
12XCS	CARB EMISSION WARR COMPLIANCE Does Not Comply with CARB Emission Warranty
12WZE	CARB IDLE COMPLIANCE Does Not Comply with California Clean Air Idle Regulations
12WVG	EPA IDLE COMPLIANCE Low NOx Idle Engine, Complies with EPA Clean Air Regulations; Includes "Certified Clean Idle" Decal on Hood
12UWZ	RADIATOR Aluminum, Cross Flow, Front to Back System, 1228 SqIn, with 1167 SqIn Charge Air Cooler, Includes In-Tank Oil Cooler
	<u>Includes</u> : DEAERATION SYSTEM with Surge Tank : HOSE CLAMPS, RADIATOR HOSES Gates Shrink Band Type; Thermoplastic Coolant Hose Clamps : RADIATOR HOSES Premium, Rubber
12THT	FAN DRIVE {Horton Drivemaster} Two-Speed Type, Direct Drive, with Residual Torque Device for Disengaged Fan Speed
	<u>Includes</u> : FAN Nylon
12VAL	AIR CLEANER Dual Element, with Integral Snow Valve and In-Cab Control
12703	ANTI-FREEZE Red, Extended Life Coolant; To -40 Degrees F/ -40 Degrees C, Freeze Protection
12849	BLOCK HEATER, ENGINE 120V/1000W, for Cummins ISB/B6.7/ISL/L9 Engines
	<u>Includes</u> : BLOCK HEATER SOCKET Receptacle Type; Mounted below Drivers Door
12VYP	ENGINE CONTROL, REMOTE MOUNTED No Provision for Remote Mounted Engine Control
12851	PTO EFFECTS, ENGINE FRONT Less PTO Unit, Includes Adapter Plate on Engine Front Mounted
12VXT	THROTTLE, HAND CONTROL Engine Speed Control; Electronic, Stationary, Variable Speed; Mounted on Steering Wheel

TRANSMISSION

13BDR	TRANSMISSION, AUTOMATIC {Allison 3500 RDS} 6th Generation Controls, Wide Ratio, 6-Speed with Double Overdrive, with PTO Provision, Less Retarder, Includes Oil Level Sensor, with 80,000-lb GVW and GCW Max, On/Off Highway
13WYH	TRANSMISSION TCM LOCATION Located Inside Cab
13WUC	ALLISON SPARE INPUT/OUTPUT for Rugged Duty Series (RDS) and Regional Haul Series (RHS), General Purpose Trucks, Construction, Package Number 223

<u>Code</u>	<u>Description</u>
13WVW	NEUTRAL AT STOP Allison Transmission Shifts to Neutral When Service Brake is Depressed and Vehicle is at Stop; Remains in Neutral Until Service Brake is Released
13XAM	PTO LOCATION Dual, Customer Intends to Install PTO at Left and/or Right Side of Transmission
13WDZ	SHIFT CONTROL PARAMETERS {Allison} 3000 or 4000 Series Transmissions, S1 Performance in Primary and Fixed Programming in Secondary
13WLP	TRANSMISSION OIL Synthetic; 29 thru 42 Pints
13WET	TRANSMISSION SHIFT CONTROL Column Mounted Stalk Shifter, Not for Use with Allison 1000 & 2000 Series Transmission

CLUTCH

11001	CLUTCH Omit Item (Clutch & Control)
-------	-------------------------------------

REAR AXLES, SUSPENSIONS

14051	AXLE, REAR, SINGLE {Meritor RS-23-160} Single Reduction, 23,000-lb Capacity, 200 Wheel Ends . Gear Ratio: 5.63
14VAJ	SUSPENSION, REAR, SINGLE 31,000-lb Capacity, Vari-Rate Springs, with 4500-lb Capacity Auxiliary Rubber Springs
14WMG	AXLE, REAR, LUBE {EmGard FE-75W-90} Synthetic Oil; 30 thru 39.99 Pints

FRONT AXLES

2ARV	AXLE, FRONT NON-DRIVING {Meritor MFS-14-143A} Wide Track, I-Beam Type, 14,000-lb Capacity
------	---

FRONT SUSPENSIONS

3AGU	SUSPENSION, FRONT, SPRING Multileaf, Shackle Type, 14,000-lb Capacity, for Reduced Deflection Vocational Use, with Shock Absorbers
------	--

CABS, COWLS, BODIES

16030	CAB Conventional, Day Cab
16ZBT	ACCESS, CAB Steel, Driver & Passenger Sides, Two Steps per Door, for use with Day Cab and Extended Cab
16BAM	AIR CONDITIONER with Integral Heater and Defroster
16WBY	ARM REST, RIGHT, DRIVER SEAT
16VKB	CAB INTERIOR TRIM Classic, for Day Cab <u>Includes</u> : CONSOLE, OVERHEAD Molded Plastic with Dual Storage Pockets, Retainer Nets and CB Radio Pocket; Located Above Driver and Passenger : DOME LIGHT, CAB Door Activated and Push On-Off at Light Lens, Timed Theater Dimming, Integral to Overhead Console, Center Mounted : SUN VISOR (2) Padded Vinyl; 2 Moveable (Front-to-Side) Primary Visors, Driver Side with Toll Ticket Strap
16WSK	CAB REAR SUSPENSION Air Bag Type
16XXC	COWL TRAY LID
16WLS	FRESH AIR FILTER Attached to Air Intake Cover on Cowl Tray in Front of Windshield Under Hood
16GED	GAUGE CLUSTER Base Level; English with English Electronic Speedometer

<u>Code</u>	<u>Description</u>
	<u>Includes</u> : GAUGE CLUSTER DISPLAY: Base Level (3" Monochromatic Display), Premium Level (5" LCD Color Display); Odometer, Voltmeter, Diagnostic Messages, Gear Indicator, Trip Odometer, Total Engine Hours, Trip Hours, MPG, Distance to Empty/Refill for : GAUGE CLUSTER Speedometer, Tachometer, Engine Coolant Temp, Fuel Gauge, DEF Gauge, Oil Pressure Gauge, Primary and Secondary Air Pressure : WARNING SYSTEM Low Fuel, Low DEF, Low Oil Pressure, High Engine Coolant Temp, Low Battery Voltage (Visual and Audible), Low Air Pressure (Primary and Secondary)
16HHE	GAUGE, AIR CLEANER RESTRICTION {Filter-Minder} Mounted in Instrument Panel
16HGH	GAUGE, OIL TEMP, AUTO TRANS for Allison Transmission
16XJP	INSTRUMENT PANEL Wing Panel
16HKA	IP CLUSTER DISPLAY Omit Display of Fault Codes in Instrument Cluster and Disable Blink Codes, Requires Service Tool to Retrieve and View Fault Code
16SNS	MIRRORS (2) Aero Pedestal, Power Adjust, Heated, Black Heads and Arms, 6.5" x 14" Flat Glass, Includes 6.5" x 6" Convex Mirrors, for 102" Load Width
	<u>Notes</u> : Mirror Dimensions are Rounded to the Nearest 0.5"
16SJW	MIRROR, CONVEX, HOOD MOUNTED {Lang Mekra} (2) Right and Left Sides, Black, Heated, 7.5" Sq.
16VLV	MONITOR, TIRE PRESSURE Omit
16JNT	SEAT, DRIVER {National 2000} Air Suspension, High Back with Integral Headrest, Vinyl, Isolator, 1 Chamber Lumbar, with 2 Position Front Cushion Adjust, -3 to +14 Degree Angle Back Adjust
16SMN	SEAT, PASSENGER {National} Non Suspension, High Back, Fixed Back, Integral Headrest, Vinyl
16WJU	WINDOW, POWER (2) and Power Door Locks, Left and Right Doors, Includes Express Down Feature
16VSL	WINDSHIELD Heated, Single Piece

FRAMES

1CBU	FRAME RAILS Heat Treated Alloy Steel (120,000 PSI Yield); 10.125" x 3.580" x 0.312" (257.2mm x 90.9mm x 8.0mm); 480.0" (12192) Maximum OAL
1LLA	BUMPER, FRONT Swept Back, Steel, Heavy Duty
1MEJ	FRAME DIMPLE Dimple on Left and Right Top Flange of Frame Rail to Reference Rear Axle Centerline
1WDS	FRAME EXTENSION, FRONT Integral; 20" In Front of Grille
1570	TOW HOOK, FRONT (2) Frame Mounted
1WEV	WHEELBASE RANGE 146" (370cm) Through and Including 195" (495cm)

BRAKES

4091	BRAKE SYSTEM, AIR Dual System for Straight Truck Applications <u>Includes</u> : BRAKE LINES Color and Size Coded Nylon : DRAIN VALVE Twist-Type : GAUGE, AIR PRESSURE (2) Air 1 and Air 2 Gauges; Located in Instrument Cluster : PARKING BRAKE CONTROL Yellow Knob, Located on Instrument Panel : PARKING BRAKE VALVE For Truck : QUICK RELEASE VALVE On Rear Axle for Spring Brake Release: 1 for 4x2, 2 for 6x4 : SPRING BRAKE MODULATOR VALVE R-7 for 4x2, SR-7 with relay valve for 6x4/8x6
------	--

<u>Code</u>	<u>Description</u>
4AZJ	AIR BRAKE ABS {Bendix AntiLock Brake System} 4-Channel (4 Sensor/4 Modulator) Full Vehicle Wheel Control System, with Automatic Traction Control
4GBM	BRAKE, PARKING Manual Push-Pull Pneumatic Parking Brake
4XDP	BRAKES, FRONT {Meritor 16.5X5 Q-PLUS CAST} Air S-Cam Type, Cast Spider, Fabricated Shoe, Double Anchor Pin, Size 16.5" X 5", 14,700-lb Capacity
4EXP	BRAKE CHAMBERS, FRONT AXLE {Bendix} 20 SqIn
4LAG	SLACK ADJUSTERS, FRONT {Gunite} Automatic
4WBX	DUST SHIELDS, FRONT BRAKE for Air Cam Brakes
4XDR	BRAKES, REAR {Meritor 16.5X7 Q-PLUS CAST} Air S-Cam Type, Cast Spider, Fabricated Shoe, Double Anchor Pin, Size 16.5" X 7", 23,000-lb Capacity per Axle
4EVH	BRAKE CHAMBERS, REAR AXLE {MGM TR3030LP3TSHD} 30/30 SqIn Spring Brake
4LGG	SLACK ADJUSTERS, REAR {Gunite} Automatic
4WDM	DUST SHIELDS, REAR BRAKE for Air Cam Brakes
4SPA	AIR COMPRESSOR {Cummins} 18.7 CFM
4EBD	AIR DRYER {Wabco System Saver 1200} with Heater
4VKC	AIR DRYER LOCATION Mounted Inside Left Rail, Back of Cab
4VKJ	AIR TANK LOCATION (2) Mounted Under Battery Box, Outside Left Rail, Back of Cab, Perpendicular to Rail
4722	DRAIN VALVE {Bendix DV-2} Automatic, with Heater, for Air Tank
4619	TRAILER CONNECTIONS Four-Wheel, with Hand Control Valve and Tractor Protection Valve, for Straight Truck

Notes

: When electronic stability control is ordered with trailer connections on a 4x2 truck, please check the operator manual for trailer weight restrictions.

STEERING

5PSA	STEERING GEAR {Sheppard M100} Power
5708	STEERING COLUMN Tilting
5CAW	STEERING WHEEL 4-Spoke; 18" Dia., Black

DRIVELINES

6DGG	DRIVELINE SYSTEM {Dana Spicer} 1710, for 4x2/6x2
------	--

EXHAUST SYSTEMS

7BLW	EXHAUST SYSTEM Horizontal Aftertreatment System, Frame Mounted Right Side Under Cab, for Single Vertical Tail Pipe, Frame Mounted Right Side Back of Cab
7BEV	AFTERTREATMENT COVER Steel, Black
7WCM	EXHAUST HEIGHT 8' 10"
7WDN	MUFFLER/TAIL PIPE GUARD (1) Aluminum
7WAZ	TAIL PIPE (1) Turnback Type

<u>Code</u>	<u>Description</u>
ELECTRICAL SYSTEMS	
8000	ELECTRICAL SYSTEM 12-Volt, Standard Equipment <u>Includes</u> : DATA LINK CONNECTOR For Vehicle Programming and Diagnostics In Cab : HAZARD SWITCH Push On/Push Off, Located on Instrument Panel to Right of Steering Wheel : HEADLIGHT DIMMER SWITCH Integral with Turn Signal Lever : PARKING LIGHT Integral with Front Turn Signal and Rear Tail Light : STARTER SWITCH Electric, Key Operated : STOP, TURN, TAIL & B/U LIGHTS Dual, Rear, Combination with Reflector : TURN SIGNAL SWITCH Self-Cancelling for Trucks, Manual Cancelling for Tractors, with Lane Change Feature : WINDSHIELD WIPER SWITCH 2-Speed with Wash and Intermittent Feature (5 Pre-Set Delays), Integral with Turn Signal Lever : WINDSHIELD WIPERS Single Motor, Electric, Cowl Mounted : WIRING, CHASSIS Color Coded and Continuously Numbered
12VYL	ACCESSORY WIRING, SPECIAL for Road Speed Wire Coiled Under Instrument Panel for Customer Use
8WXD	ALARM, PARKING BRAKE Electric Horn Sounds in Repetitive Manner When Vehicle Park Brake is "NOT" Set, with Ignition "OFF" and any Door Opened
8GXD	ALTERNATOR {Leece-Neville AVI160P2013} Brush Type, 12 Volt, 160 Amp Capacity, Pad Mount, with Remote Sense
8RPR	ANTENNA for Increased Roof Clearance Applications
8THJ	AUXILIARY HARNESS 3.0' for Auxiliary Front Head Lights and Turn Signals for Front Plow Applications
8THB	BACK-UP ALARM Electric, 102 dBA
8VUL	BATTERY BOX Steel, with Plastic Cover, 18" Wide, 2-4 Battery Capacity, Mounted Left Side Back of Cab
8TNR	BATTERY CABLES with 36" of Extra Length Coiled and Strapped Near Battery Box
8MSG	BATTERY SYSTEM {Fleetrite} Maintenance-Free, (3) 12-Volt 1980CCA Total, Top Threaded Stud
8HAB	BODY BUILDER WIRING Back of Day Cab at Left Frame or Under Sleeper, Extended or Crew Cab at Left Frame; Includes Sealed Connectors for Tail/Amber Turn/Marker/ Backup/Accessory Power/Ground and Sealed Connector for Stop/Turn
8XAH	CIRCUIT BREAKERS Manual-Reset (Main Panel) SAE Type III with Trip Indicators, Replaces All Fuses
8518	CIGAR LIGHTER Includes Ash Cup
8WPH	CLEARANCE/MARKER LIGHTS (5) {Truck Lite} Amber LED Lights, Flush Mounted on Cab or Sunshade
8WTP	COURTESY LIGHT (2) Mounted In Front Map Pocket Left and Right Side
8XNY	HEADLIGHTS Halogen
8WRB	HEADLIGHTS ON W/WIPERS Headlights Will Automatically Turn On if Windshield Wipers are Turned On
8XHN	HORN, AIR Single Trumpet, Black, with Lanyard Pull Cord
8541	HORN, ELECTRIC (2) Disc Style
8WWJ	INDICATOR, LOW COOLANT LEVEL with Audible Alarm
8XPK	POWER SOURCE, ADDITIONAL Auxiliary Power Outlet (APO) with USB-A Port and USB-C Port, Located in the Instrument Panel
8RPS	RADIO AM/FM/WB/Clock/Bluetooth/USB Input/Auxiliary Input

<u>Code</u>	<u>Description</u>
8RPB	RADIO, AUXILIARY CONTROLS Mounted in Steering Wheel, Radio Function Control Switch, Includes Volume Up/Down, Mute, Forward/Back and Bluetooth Answer/Disconnect
8RMZ	SPEAKERS (2) 6.5" Dual Cone Mounted in Both Doors, (2) 5.25" Dual Cone Mounted in Both B-Pillars
8WTK	STARTING MOTOR {Delco Remy 38MT Type 300} 12 Volt, Less Thermal Over-Crank Protection
8TPR	STOP, TURN, TAIL & B/U LIGHTS {Weldon} Multi-Function LED Lamp, Mounted Outside Rails, Includes LED License Plate Light
8WPZ	TEST EXTERIOR LIGHTS Pre-Trip Inspection will Cycle all Exterior Lamps Except Back-up Lights
8TME	TRAILER CONNECTION SOCKET {Phillips} 7-Way, Mounted at Rear of Frame, Wired for Turn Signals Independent of Stop, Compatible with Trailers with Amber or Side Turn Lamps
8XGT	TURN SIGNALS, FRONT Includes LED Side Turn Lights Mounted on Fender
8XPN	USB PORT One USB-A Port and One USB-C Port, Located in Instrument Panel
8WGL	WINDSHIELD WIPER SPD CONTROL Force Wipers to Slowest Intermittent Speed When Park Brake Set and Wipers Left on for a Predetermined Time

FRONT END

9WBC	FRONT END Tilting, Fiberglass, with Three Piece Construction, for WorkStar/HV
9HBM	GRILLE Stationary, Chrome
9AAB	LOGOS EXTERIOR Model Badges
9AAE	LOGOS EXTERIOR, ENGINE Badges

SPEEDOMETER, TOOLS, MISC

10021	CHASSIS COATING Corrosion Resistant E-Coat Primer Coating for Single Frame Rails
10AGB	COMMUNICATIONS MODULE Telematics Device with Over the Air Programming; Includes Five Year Data Plan and International 360
10JPA	CUSTOMER IDENTITY for Sourcewell
10060	PAINT SCHEMATIC, PT-1 Single Color, Design 100 <u>Includes</u> : PAINT SCHEMATIC ID LETTERS "WK"
10761	PAINT TYPE Base Coat/Clear Coat, 1-2 Tone
10SLV	PROMOTIONAL PACKAGE Government Silver Package

FUEL TANKS

15SGG	FUEL TANK Top Draw, Non-Polished Aluminum, D-Style, 19" Tank Depth, 70 US Gal (265L), Mounted Left Side, Under Cab
15WDG	DEF TANK 7 US Gal (26L) Capacity, Frame Mounted Outside Left Rail, Under Cab
15LNS	FUEL/WATER SEPARATOR {Racor 400 Series} 12 VDC Electric Heater, Includes Pre-Heater, with Primer Pump, Includes Water-in-Fuel Sensor, Mounted on Engine

WHEELS, TIRES - FRONT

27DTT	WHEELS, FRONT {Accuride 28828} DISC; 22.5x8.25 Rims, Powder Coat Steel, 2-Hand Hole, 10-Stud, 285.75mm BC, Hub-Piloted, Flanged Nut, with .472" Thick Increased Capacity Disc and with Steel Hubs
-------	---

<u>Code</u>	<u>Description</u>
7382135439	(2) TIRE, FRONT 11R22.5 Load Range H HSR 3 (CONTINENTAL), 494 rev/mile, 75 MPH, All-Position

WHEELS, TIRES - REAR

28DTT	WHEELS, REAR {Accuride 28828} DUAL DISC; 22.5x8.25 Rims, Powder Coat Steel, 2-Hand Hole, 10-Stud, 285.75mm BC, Hub-Piloted, Flanged Nut, with .472" Thick Increased Capacity Disc and with Steel Hubs
7382135444	(4) TIRE, REAR 11R22.5 Load Range H HDR2+ (CONTINENTAL), 491 rev/mile, 75 MPH, Drive

WHEELS MISC OPTIONS

29WLK	WHEEL BEARING, FRONT, LUBE {EmGard FE-75W-90} Synthetic Oil
29WAP	WHEEL GUARDS, FRONT {Accuride} for Metric Hub Piloted Wheels with Flanged Mounting Nuts Mounted Between Hub and Wheel
29WAR	WHEEL GUARDS, REAR {Accuride} for Metric Hub Piloted Wheels with Flanged Mounting Nuts, Mounted Between Hub & Wheel and Between Dual Wheels

BODY INTEGRATION

60AAG	BDY INTG, REMOTE POWER MODULE Mounted Inside Cab Behind Driver Seat, Up to 6 Outputs & 6 Inputs, Max 20 amp per Channel, Max 80 amp Total; Includes 1 Switch Pack with Latched Switches
-------	---

Services Section:

WARRANTY

40128	WARRANTY Standard for HV507, HV50B, HV607 Models, Effective with Vehicles Built July 1, 2017 or Later, CTS-2025A
40YZL	SRV CONTRACT, EXT CMS ENG/AFTR {Cummins} To 60-Month/100,000 Miles (160,000 km), Extended Cummins L9 Engine Coverage, Protection Plan 1 and Aftertreatment, (Truck Application Only)

received
12-28-2023

Item No. B.-5.

CITY OF OTTUMWA Staff Summary

**** ACTION ITEM ****

Council Meeting of: Jan 2, 2024

Philip Rath

Prepared By

Administration

Department

Department Head

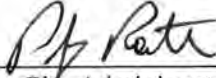

City Administrator Approval

AGENDA TITLE: Resolution 1-2024 - Set January 16, 2024 at 5:30 PM for the Public Hearing for the Purpose of Considering a Ten-Year Municipal Lease and Operating Agreement Between the City of Ottumwa and A. A. W. Golf Group, LLC

Public hearing required if this box is checked.

RECOMMENDATION: Pass and adopt Resolution 1-2024

DISCUSSION: The City of Ottumwa owns the property known as Cedar Creek Golf Course. The current operator is retiring and the city council accepted proposals to identify a successor. Adam Wilson d/b/a A. A. W. Golf Group, LLC was awarded the opportunity to operate the course. City staff is negotiating an agreement with Wilson. Due to the length of the lease, a public hearing is required and requested for the January 16, 2024 meeting.

Source of Funds: N/A

Budgeted Item:

Budget Amendment Needed:

RESOLUTION NO. | -2024

RESOLUTION SETTING TIME AND PLACE FOR A PUBLIC HEARING FOR THE PURPOSE OF CONSIDERING A MUNICIPAL LEASE AND OPERATING AGREEMENT BETWEEN THE CITY OF OTTUMWA AND A. A. W. GOLF GROUP, LLC FOR CEDAR CREEK GOLF COURSE

WHEREAS, the City owns certain improved real estate in Wapello County, Ottumwa, Iowa, which is used and maintained as a municipal Golf Course and is commonly known as Cedar Creek Golf Course (“Golf Course”), located at 13120 Angle Road; and

WHEREAS, the City has determined that it is in the best interest of the citizens of the City of Ottumwa to procure the services of the Contractor to manage and operate the Golf Course on behalf of the City; and

WHEREAS, agreements exceeding three years require a public hearing; and

WHEREAS, interested residents or taxpayers having comment for or against the stated lease agreement may appear and be heard at a public hearing held for stated purpose during the meeting of the City Council at the Bridge View Center, at 102 Church Street, Ottumwa, Iowa.

NOW, THEREFORE, BE IT RESOLVED, by the City Council of the City of Ottumwa, Iowa, that a public hearing will be scheduled and held on January 16, 2024 during the meeting of the City Council scheduled to begin at 5:30 PM; and

BE IT FURTHER RESOLVED, by the Ottumwa City Council of the City of Ottumwa, Iowa, that the City Clerk is directed to publish notice of said meeting in accordance with law; and

BE IT FURTHER RESOLVED, by the Ottumwa City Council of the City of Ottumwa, Iowa, that the Mayor and City Clerk are hereby authorized and directed to execute said resolution.

APPROVED, PASSED AND ADOPTED, this 2nd day of January, 2024.

CITY OF OTTUMWA, IOWA

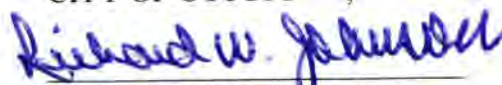
Richard W. Johnson, Mayor

ATTEST:

Christina Reinhard, City Clerk

received
12-29-23 915A

Item No. B.-6.

CITY OF OTTUMWA

Staff Summary

**** ACTION ITEM ****

Council Meeting of: January 2, 2024

Engineering Department
Department

Phillip Burgmeier
Prepared By
Phillip Burgmeier
Department Head

P. Kelly
City Administrator Approval

AGENDA TITLE: Resolution #4-2024. Approving the contract, bonds, and certificate of insurance for the Elm Street and Fellows Avenue Reconstruction Project.

**Public hearing required if this box is checked. **

The Proof of Publication for each Public Hearing must be attached to this Staff Summary. If the Proof of Publication is not attached, the item will not be placed on the agenda.

RECOMMENDATION: Pass and adopt Resolution #4-2024.

DISCUSSION: This project involves two street projects being bid together. The first project is the full-width, full depth PCC Reconstruction of Elm Street from Main Street to 2nd Street. This project also includes new storm and sanitary sewer. The second project is the full-width, full depth PCC Reconstruction of Fellows Avenue from Main Street to 2nd Street. This project includes storm and sanitary sewer repairs where needed.

These are the required bonds, certificate of insurance and signed contract with Jones Contracting Corp of West Point, Iowa for the above referenced project and are now on file with the City Clerk. This project was awarded at the December 19, 2023 City Council Meeting in the amount of \$998,554.00.

\$ 998,665.00 Bid Amount

\$1,370,000.00 Estimated cost

\$1,303,000.00 Budgeted Amount

Source of Funds: LOST

Budgeted Item: Yes

Budget Amendment Needed: No

RESOLUTION #4-2024

A RESOLUTION APPROVING THE CONTRACT, BONDS, AND CERTIFICATE OF INSURANCE FOR THE ELM STREET AND FELLOWS AVE RECONSTRUCTION PROJECT

WHEREAS, The City Council of the City of Ottumwa, Iowa accepted bids for the above referenced project and awarded the contract to Jones Contracting Corp of West Point, Iowa in the amount of \$998,554.00 based on total unit price and estimated quantities; and,

WHEREAS, All proper bonds and a certificate of insurance have been filed with the City Clerk and the contract executed.

NOW, THEREFORE, BE IT RESOLVED, BY THE CITY COUNCIL OF THE CITY OF OTTUMWA, IOWA THAT: The contract, bond and certificate of insurance with Jones Contracting Corp of West Point, Iowa, for the above referenced project are hereby approved.

APPROVED, PASSED, AND ADOPTED, this 2nd day of January, 2024.

CITY OF OTTUMWA, IOWA

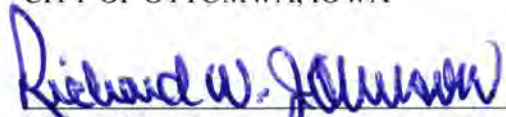
Richard W. Johnson, Mayor

ATTEST:

Christina Reinhard, City Clerk

SECTION 00500
CONTRACT

THIS AGREEMENT, made and entered into this 2nd day of January, 2024, by and between the **City of Ottumwa, Wapello County, Iowa**, the party of the first part, hereinafter called the OWNER and **Jones Contracting Corp of West Point, Iowa**, the party of the second part, hereinafter called the CONTRACTOR.

WITNESSETH, the Contractor and the Owner for the consideration hereinafter named agree as follow:

ARTICLE I

SCOPE OF WORK. The Contractor shall furnish all materials and perform all work shown on the Plans and described in the Specifications entitled: "**Elm Street and Fellows Avenue Reconstruction Project - Ottumwa, Iowa**" prepared by the City Engineering Department of Ottumwa, Iowa, acting as and in these documents entitled, the ENGINEER, and shall do everything required by this Agreement, the General Conditions of the Contract, the Specifications and the Plans.

ARTICLE II

TIME OF COMPLETION. The work performed under this Contract shall be commenced within fifteen (15) days after the issuance of the "Notice to Proceed" and shall be completed **within 45 working days for the Fellows Avenue Project and 60 days for the Elm Street Project** and in accordance with any special timeframes as indicated on construction documents. The time of commencing and completing said work is the essence of this Contract.

ARTICLE III

THE CONTRACT SUM. The Owner shall pay the Contractor the sum of **\$998,554.00** payable as set forth in Article IV below, for the performance of the Contract subject to increases or decreases as provided in the Specifications.

ARTICLE IV

PROGRESS PAYMENTS. In consideration to the foregoing, the Owner agrees to make payments according and subject to the conditions set forth in the Official Notice and Specifications.

ARTICLE V

CONTRACTOR'S RESPONSIBILITY: The Contractor assumes full responsibility for the safekeeping of all materials and equipment and for all unfinished work until final acceptance by the Owner, and if any of it be damaged or be destroyed from any cause, he shall replace it at his own expense.

The Contractor shall indemnify and hold harmless the Owner against any liens filed for nonpayment of his bills in connection with the Contract work. The Contractor shall furnish the Owner satisfactory evidence that all persons who have done work or furnished materials, equipment or service of any type under this Contract have been fully paid prior to the acceptance of the work by the Owner.

The Contractor agrees to accept full responsibility for all construction means, methods, sequences, techniques, proceedings, property and personal safety on the project site, including the same for all subcontractors, and do not expect that the Owner, Engineer or Engineer's Representatives will assume any of these duties or responsibilities.

A certificate of insurance for liability, bodily injury and property damage satisfactory to the Owner in the amount of **\$300,000** for each person bodily injury and **\$1,000,000** per occurrence of or aggregate limit, or **\$1,000,000** combined single limit. The Owner must be included as an additional insured to the certificate of insurance. Also, Worker's Compensation coverage in accordance with State of Iowa statutes must be provided.

The Contractor shall indemnify and hold harmless the Owner, the Owner's employees, the Engineer, and the Engineer's employees from any and all liability, loss, cost, damage, and expense (including reasonable attorney's fees and court costs) resulting from, arising out of, or incurred by reason of any claims, actions, or suits based upon or alleging bodily injury, including death, or property damage rising out of or resulting from the Contractor's operations under this Contract, whether such operations be by himself or by any subcontractor or by anyone directly or indirectly employed by either of them. The Contractor shall obtain insurance for this purpose, which shall insure the interests of the Owner and Engineer as the same may appear, and shall file with the Owner and Engineer certificates of such insurance.

ARTICLE VI

ACCEPTANCE AND FINAL PAYMENT. The manner of making final acceptance and final payment shall be as provided in the Specifications. The Owner may require the Contractor to show satisfactory evidence that all payroll, materials, bills and other indebtedness connected with the work shall have been paid before final acceptance of the work. The making and acceptance of the final payment shall constitute a waiver of all claims by the Owner other than those arising from unsettled liens and from all claims by the Contractor except those previously made and still unsettled, and except potential claims by owner against Contractor pursuant to the four (4) year warranty or guaranty period as provided for in the specifications, the Notice of Letting and the Performance Bond.

ARTICLE VII

CONTRACT DOCUMENTS. The Official Notice, the Proposal, this Contract, Detailed Plan Drawings and Specifications (including Measurement and Payment), the General Specifications, the Instruction to Bidders, the Special Conditions, the General Conditions and the Contractor's Bond and the Performance Bond form the Contract and they are as fully a part of this Agreement and Contract and to the same effect as if each of them had been set forth in complete detail herein.

IN WITNESS WHEREOF. The parties have executed this Agreement and Contract and one other of like tenor as of the day and year first above written.

CITY OF OTTUMWA, IOWA

By Richard W. Johnson
Title Mayor

ATTEST:

Christina Reinhard
Title City Clerk

JONES CONTRACTING CORP

Contractor
By [Signature]
Title PRESIDENT
Address PO BOX 156
City, State, Zip WEST POINT, IA 52656



CERTIFICATE OF LIABILITY INSURANCE

DATE (MM/DD/YYYY)

12/21/2023

THIS CERTIFICATE IS ISSUED AS A MATTER OF INFORMATION ONLY AND CONFERS NO RIGHTS UPON THE CERTIFICATE HOLDER. THIS CERTIFICATE DOES NOT AFFIRMATIVELY OR NEGATIVELY AMEND, EXTEND OR ALTER THE COVERAGE AFFORDED BY THE POLICIES BELOW. THIS CERTIFICATE OF INSURANCE DOES NOT CONSTITUTE A CONTRACT BETWEEN THE ISSUING INSURER(S), AUTHORIZED REPRESENTATIVE OR PRODUCER, AND THE CERTIFICATE HOLDER.

IMPORTANT: If the certificate holder is an ADDITIONAL INSURED, the policy(ies) must have ADDITIONAL INSURED provisions or be endorsed. If SUBROGATION IS WAIVED, subject to the terms and conditions of the policy, certain policies may require an endorsement. A statement on this certificate does not confer rights to the certificate holder in lieu of such endorsement(s).

PRODUCER Holmes Murphy & Associates 2727 Grand Prairie Parkway Waukee IA 50263		CONTACT NAME: Nate Collins PHONE (A/C, No, Ext): _____ FAX (A/C, No): _____ E-MAIL ADDRESS: ncollins@holmesmurphy.com	
INSURED Jones Contracting Corp. PO Box 156 West Point, IA 52656		INSURER(S) AFFORDING COVERAGE	
JONCONPC		INSURER A : Sentry Casualty Company	NAIC # 28460
		INSURER B :	
		INSURER C :	
		INSURER D :	
		INSURER E :	
		INSURER F :	

COVERAGES

CERTIFICATE NUMBER: 1447061926

REVISION NUMBER:

THIS IS TO CERTIFY THAT THE POLICIES OF INSURANCE LISTED BELOW HAVE BEEN ISSUED TO THE INSURED NAMED ABOVE FOR THE POLICY PERIOD INDICATED. NOTWITHSTANDING ANY REQUIREMENT, TERM OR CONDITION OF ANY CONTRACT OR OTHER DOCUMENT WITH RESPECT TO WHICH THIS CERTIFICATE MAY BE ISSUED OR MAY PERTAIN, THE INSURANCE AFFORDED BY THE POLICIES DESCRIBED HEREIN IS SUBJECT TO ALL THE TERMS, EXCLUSIONS AND CONDITIONS OF SUCH POLICIES. LIMITS SHOWN MAY HAVE BEEN REDUCED BY PAID CLAIMS.

INSR LTR	TYPE OF INSURANCE	ADDL SUBR INSD WVD	POLICY NUMBER	POLICY EFF (MM/DD/YYYY)	POLICY EXP (MM/DD/YYYY)	LIMITS
A	<input checked="" type="checkbox"/> COMMERCIAL GENERAL LIABILITY <input type="checkbox"/> CLAIMS-MADE <input checked="" type="checkbox"/> OCCUR GEN'L AGGREGATE LIMIT APPLIES PER: <input type="checkbox"/> POLICY <input checked="" type="checkbox"/> PRO-JECT <input checked="" type="checkbox"/> LOC <input type="checkbox"/> OTHER:		A0217491004	5/1/2023	5/1/2024	EACH OCCURRENCE \$ 1,000,000 DAMAGE TO RENTED PREMISES (Ea occurrence) \$ 300,000 MED EXP (Any one person) \$ 10,000 PERSONAL & ADV INJURY \$ 1,000,000 GENERAL AGGREGATE \$ 2,000,000 PRODUCTS - COMP/OP AGG \$ 2,000,000 \$
A	<input checked="" type="checkbox"/> AUTOMOBILE LIABILITY <input checked="" type="checkbox"/> ANY AUTO <input type="checkbox"/> OWNED AUTOS ONLY <input type="checkbox"/> SCHEDULED AUTOS <input checked="" type="checkbox"/> HIRED AUTOS ONLY <input checked="" type="checkbox"/> NON-OWNED AUTOS ONLY		A0217491001	5/1/2023	5/1/2024	COMBINED SINGLE LIMIT (Ea accident) \$ 1,000,000 BODILY INJURY (Per person) \$ BODILY INJURY (Per accident) \$ PROPERTY DAMAGE (Per accident) \$ \$
A	<input checked="" type="checkbox"/> UMBRELLA LIAB <input checked="" type="checkbox"/> OCCUR <input type="checkbox"/> EXCESS LIAB <input type="checkbox"/> CLAIMS-MADE <input type="checkbox"/> DED <input type="checkbox"/> RETENTION \$		A0217491007	5/1/2023	5/1/2024	EACH OCCURRENCE \$ 5,000,000 AGGREGATE \$ 5,000,000 \$
A	<input checked="" type="checkbox"/> WORKERS COMPENSATION AND EMPLOYERS' LIABILITY ANY PROPRIETOR/PARTNER/EXECUTIVE OFFICER/MEMBER EXCLUDED? (Mandatory in NH) If yes, describe under DESCRIPTION OF OPERATIONS below	Y/N <input checked="" type="checkbox"/> N <input type="checkbox"/> N/A	A0217491006	5/1/2023	5/1/2024	<input checked="" type="checkbox"/> PER STATUTE <input type="checkbox"/> OTH-ER E.L. EACH ACCIDENT \$ 1,000,000 E.L. DISEASE - EA EMPLOYEE \$ 1,000,000 E.L. DISEASE - POLICY LIMIT \$ 1,000,000

DESCRIPTION OF OPERATIONS / LOCATIONS / VEHICLES (ACORD 101, Additional Remarks Schedule, may be attached if more space is required)

Project Reference: Elm Street and Fellows Avenue Reconstruction Project, Ottumwa, IA

CERTIFICATE HOLDER**CANCELLATION**

City of Ottumwa
 105 East Third St.
 Ottumwa IA 52501

SHOULD ANY OF THE ABOVE DESCRIBED POLICIES BE CANCELLED BEFORE THE EXPIRATION DATE THEREOF, NOTICE WILL BE DELIVERED IN ACCORDANCE WITH THE POLICY PROVISIONS.

AUTHORIZED REPRESENTATIVE

Kari Coolidge

SECTION 00510

**PLEASE NOTE: THIS IS A NEW FORM TO COMPLY WITH SUDAS STANDARDS.
PLEASE HAVE YOUR BONDING COMPANY USE THIS FORM.**

**PERFORMANCE, PAYMENT, AND
MAINTENANCE BOND**

Bond Number 364019C

PRINCIPAL (Legal Name and Business Address)

Jones Contracting Corp.
P. O. Box 156
West Point, IA 52656

STATE OF INCORPORATION

Iowa

SURETY (Legal Name and Business Address)

Westfield Insurance Company
P. O. Box 5001
Westfield Center, OH 44251

CONTRACT NO.

CONTRACT DATE

January 2, 2024

PENAL SUM OF BOND (Expressed in words and numerals)

Nine Hundred Ninety Eight Thousand Five Hundred Fifty Four and No/100-----(\$998,554.00)-----

KNOW ALL BY THESE PRESENTS:

That we, **Jones Contracting Corp.**, as Principal (hereinafter the "CONTRACTOR" or "PRINCIPAL" and **Westfield Insurance Company**, as SURETY are held and firmly bound unto *the City of Ottumwa, Iowa*, as OBLIGEE (hereinafter referred to as "the OWNER"), and to all persons who may be injured by any breach of any of the conditions of this Bond in the penal sum of **Nine Hundred Ninety Eight Thousand Five Hundred Fifty Four and No/100-----** dollars (\$ **998,554.00**), lawful money of the United States, for the payment of which sum, well and truly to be made, we bind ourselves, our heirs, legal representatives and assigns, jointly or severally, firmly by these presents.

The conditions of the above obligations are such that whereas said CONTRACTOR entered into a contract with the OWNER, bearing date the 2nd day of January, 2024, wherein said CONTRACTOR undertakes and agrees to construct the following described improvements:

Project Name: **Elm Street and Fellows Avenue Reconstruction Project**

Project Location: **City of Ottumwa, Iowa**

The Work generally consists of:

This project involves two street projects being bid together. The first project is the full-width, full depth PCC Reconstruction of Elm Street from Main Street to 2nd Street. This project also includes new storm and sanitary sewer. The second project is the full-width, full depth PCC Reconstruction of Fellows Avenue from Main Street to 2nd Street. This project includes storm and sanitary sewer repairs where needed.

which said contract and associated contract documents, including any present or future amendment thereto, is incorporated herein by reference and is hereinafter referred to as the "Contract."

SECTION 00510

(CON'T – PERFORMANCE, PAYMENT, AND MAINTENANCE BOND)

and to faithfully perform all the terms and requirements of said Contract within the time therein specified, in a good and workmanlike manner, and in accordance with the Contract Documents.

It is expressly understood and agreed by the CONTRACTOR and SURETY in this bond that the following provisions are a part of this Bond and are binding upon said CONTRACTOR and SURETY, to-wit:

1. **PERFORMANCE:** The CONTRACTOR shall well and faithfully observe, perform, fulfill, and abide by each and every covenant, condition, and part of said Contract and Contract Documents, by reference made a part hereof, for the above referenced improvements, and shall indemnify and save harmless the OWNER from all outlay and expense incurred by the OWNER by reason of the CONTRACTOR's default of failure to perform as required. The CONTRACTOR shall also be responsible for the default or failure to perform as required under the Contract and Contract Documents by all its subcontractors, suppliers, agents, or employees furnishing materials or providing labor in the performance of the Contract.
2. **PAYMENT:** The CONTRACTOR and the SURETY on this Bond hereby agreed to pay all just claims submitted by persons, firms, subcontractors, and corporations furnishing materials for or performing labor in the performance of the Contract on account of which this Bond is given, including but not limited to claims for all amounts due for labor, materials, lubricants, oil, gasoline, repairs on machinery, equipment, and tools, consumed or used by the CONTRACTOR or any subcontractor, wherein the same are not satisfied out of the portion of the contract price the OWNER is required to retain until completion of the improvement, but the CONTRACTOR and SURETY shall not be liable to said persons, firms, or corporations unless the claims of said claimants against said portion of the contract price shall have been established as provided by law. The CONTRACTOR and SURETY hereby bind themselves to the obligations and conditions set forth in Chapter 573 of the Iowa Code, which by this reference is made a part hereof as though fully set out herein.
3. **MAINTENANCE:** The CONTRACTOR and the SURETY on this Bond hereby agree, at their own expense:
 - A. To remedy any and all defects that may develop in or result from work to be performed under the Contract within the period of four (4) years from the date of acceptance of the work under the Contract, by reason of defects in workmanship or materials used in construction of said work;
 - B. To keep all work in continuous good repair; and
 - C. To pay the OWNER's reasonable costs of monitoring and inspection to assure that any defects are remedied, and to repay the OWNER all outlay and expense incurred as a result of CONTRACTOR's and SURETY's failure to remedy any defect as required by this section.

SECTION 00510

(CON'T – PERFORMANCE, PAYMENT, AND MAINTENANCE BOND)

4. GENERAL: Every SURETY on this Bond shall be deemed and held bound, any contract to the contrary notwithstanding, to the following provisions:
- A. To consent without notice to any extension of time to the CONTRACTOR in which to perform the Contract;
 - B. To consent without notice to any change in the Contract or Contract Documents, which thereby increases the total contract price and the penal sum of this bond, provided that all such changes do not, in the aggregate, involve an increase of more than 20% of the total contract price, and that this bond shall then be released as to such excess increase; and
 - C. To consent without notice that this Bond shall remain in full force and effect until the Contract is completed, whether completed within the specified contract period, within an extension thereof, or within a period of time after the contract period has elapsed and the liquidated damage penalty is being charged against the CONTRACTOR.
 - D. That no provision of this Bond or of any other contract shall be valid that limits to less than four (4) years after the acceptance of the work under the Contract the right to sue on this Bond.
 - E. That as used herein, the phrase "all outlay and expense" is not to be limited in any way, but shall include the actual and reasonable costs and expenses incurred by the OWNER including interest, benefits, and overhead where applicable. Accordingly, "all outlay and expense" would include but not be limited to all contract or employee expense, all equipment usage or rental, materials, testing, outside experts, attorneys' fees (including overhead expenses of the OWNER's staff attorneys), and all costs and expenses of litigation as they are incurred by the OWNER. It is intended the CONTRACTOR and SURETY will defend and indemnify the OWNER on all claims made against the OWNER on account of CONTRACTOR's failure to perform as required in the Contract and Contract Documents, that all agreements and promises set forth in the Contract and Contract Documents, in approved change orders, and in this Bond will be fulfilled, and that the OWNER will be fully indemnified so that it will be put into the position it would have been in had the Contract been performed in the first instance as required.

In the event the OWNER incurs any "outlay and expense" in defending itself against any claim as to which the CONTRACTOR or SURETY should have provided the defense, or in the enforcement of the promises given by the CONTRACTOR in the Contract, Contract Documents, or approved change orders, or in the enforcement of the promises given by the CONTRACTOR and SURETY in this Bond, the CONTRACTOR and SURETY agree that they will make the OWNER whole for all such outlay and expense, provided that the SURETY's obligation under this bond shall not exceed 125% of the penal sum of this bond.

SECTION 00510

(CON'T - PERFORMANCE, PAYMENT AND MAINTENANCE BOND)

In the event that any actions or proceedings are initiated regarding this Bond, the parties agree that the venue thereof shall be in either the Iowa District Court in Wapello County, Iowa or the United States District Court for the Southern District of Iowa in Des Moines. If legal action is required by the OWNER to enforce the provisions of this Bond or to collect the monetary obligation incurring to the benefit of the OWNER, the CONTRACTOR and the SURETY agree, jointly, and severally, to pay the OWNER all outlay and expense incurred therefor by the OWNER. All rights, powers, and remedies of the OWNER hereunder shall be cumulative and not alternative and shall be in addition to all rights, powers, and remedies given to the OWNER, by law. The OWNER may proceed against SURETY for any amount guaranteed hereunder whether action is brought against the CONTRACTOR or whether CONTRACTOR is joined in any such action(s) or not.

NOW THEREFORE, the condition of this obligation is such that if said Principal shall faithfully perform all the promises of the Principal, as set forth and provided in the Contract, in the Contract Documents, and in this Bond, then this obligation shall be null and void, otherwise it shall remain in full force and effect.

When a work, term, or phrase is used in this Bond, it shall be interpreted or construed first as defined in this Bond, the Contract, or the Contract Documents; second, if not defined in the Bond, Contract, or Contract Documents, it shall be interpreted or construed as defined in applicable provisions of the Iowa Code; third, if not defined in the Iowa Code, it shall be interpreted or construed according to its generally accepted meaning in the construction industry; and fourth, if it has no generally accepted meaning in the construction industry, it shall be interpreted or construed according to its common or customary usage.

Failure to specify or particularize shall not exclude terms or provisions not mentioned and shall not limit liability hereunder. The Contract and Contract Documents are hereby made a part of this Bond.

(CON'T – PERFORMANCE, PAYMENT, AND MAINTENANCE BOND) Project No. _____

Witness our hands, in triplicate, this 2nd day of January, 2024.

Surety Countersigned By:

PRINCIPAL:

Not Required
Signature of Agent

Jones Contracting Corp.
Contractor

Printed Name of Agent

By: [Signature]
Signature
President
Title

Company Name

SURETY:

Company Address

Westfield Insurance Company
Surety Company

City, State, Zip Code

By: [Signature]
Signature Attorney-in-Fact Officer

Company Telephone Number

Cindy Bennett, Attorney-in-fact & Iowa Resident Agent
Printed Name of Attorney-in-Fact Officer

Holmes, Murphy and Associates LLC
Company Name

2727 Grand Prairie Parkway
Company Address

Waukee, IA 50263
City, State, Zip Code

(515) 223-6800
Company Telephone Number

NOTE:

1. All signatures on this performance, payment, and maintenance bond must be original signatures in ink; copies, facsimile, or electronic signatures will not be accepted.
2. This bond must be sealed with the Surety's raised, embossing seal.
3. The Certificate or Power of Attorney accompanying this bond must be valid on its face and sealed with the Surety's raised, embossing seal.
4. The name and signature of the Surety's Attorney-in-Fact/Officer entered on this bond must be exactly as listed on the Certificate or Power of Attorney accompanying this bond.

THIS POWER OF ATTORNEY SUPERCEDES ANY PREVIOUS POWER BEARING THIS SAME POWER # AND ISSUED PRIOR TO 07/24/23, FOR ANY PERSON OR PERSONS NAMED BELOW.

POWER NO. 1429262 15

General
Power
of Attorney

Westfield Insurance Co.
Westfield National Insurance Co.
Ohio Farmers Insurance Co.
Westfield Center, Ohio

CERTIFIED COPY

Know All Men by These Presents, That WESTFIELD INSURANCE COMPANY, WESTFIELD NATIONAL INSURANCE COMPANY and OHIO FARMERS INSURANCE COMPANY, corporations, hereinafter referred to individually as a "Company" and collectively as "Companies," duly organized and existing under the laws of the State of Ohio, and having its principal office in Westfield Center, Medina County, Ohio, do by these presents make, constitute and appoint
CRAIG E. HANSEN, JAY D. FREIERMUTH, BRIAN M. DEIMERLY, CINDY BENNETT, ANNE CROWNER, TIM MCCULLOH, DIONE R. YOUNG, SETH ROOKER, SARA HUSTON, KATE ZANDERS, JOHN CORD, GRACE RASMUSSEN, JOINTLY OR SEVERALLY

of WAUKEE and State of IA its true and lawful Attorney(s)-in-Fact, with full power and authority hereby conferred in its name, place and stead, to execute, acknowledge and deliver any and all bonds, recognizances, undertakings, or other instruments or contracts of suretyship in any penal limit.

LIMITATION: THIS POWER OF ATTORNEY CANNOT BE USED TO EXECUTE NOTE GUARANTEE, MORTGAGE DEFICIENCY, MORTGAGE GUARANTEE, OR BANK DEPOSITORY BONDS.

and to bind any of the Companies thereby as fully and to the same extent as if such bonds were signed by the President, sealed with the corporate seal of the applicable Company and duly attested by its Secretary, hereby ratifying and confirming all that the said Attorney(s)-in-Fact may do in the premises. Said appointment is made under and by authority of the following resolution adopted by the Board of Directors of each of the WESTFIELD INSURANCE COMPANY, WESTFIELD NATIONAL INSURANCE COMPANY and OHIO FARMERS INSURANCE COMPANY:

"Be it Resolved, that the President, any Senior Executive, any Secretary or any Fidelity & Surety Operations Executive or other Executive shall be and is hereby vested with full power and authority to appoint any one or more suitable persons as Attorney(s)-in-Fact to represent and act for and on behalf of the Company subject to the following provisions:

The Attorney-in-Fact may be given full power and authority for and in the name of and on behalf of the Company, to execute, acknowledge and deliver, any and all bonds, recognizances, contracts, agreements of indemnity and other conditional or obligatory undertakings and any and all notices and documents canceling or terminating the Company's liability thereunder, and any such instruments so executed by any such Attorney-in-Fact shall be as binding upon the Company as if signed by the President and sealed and attested by the Corporate Secretary."

"Be it Further Resolved, that the signature of any such designated person and the seal of the Company heretofore or hereafter affixed to any power of attorney or any certificate relating thereto by facsimile, and any power of attorney or certificate bearing facsimile signatures or facsimile seal shall be valid and binding upon the Company with respect to any bond or undertaking to which it is attached." (Each adopted at a meeting held on February 8, 2000).

In Witness Whereof, WESTFIELD INSURANCE COMPANY, WESTFIELD NATIONAL INSURANCE COMPANY and OHIO FARMERS INSURANCE COMPANY have caused these presents to be signed by their National Surety Leader and Senior Executive and their corporate seals to be hereto affixed this 24th day of JULY A.D., 2023 .

Corporate
Seals
Affixed



WESTFIELD INSURANCE COMPANY
WESTFIELD NATIONAL INSURANCE COMPANY
OHIO FARMERS INSURANCE COMPANY

By: **Gary W. Stumper, National Surety Leader and Senior Executive**

State of Ohio
County of Medina ss.:

On this 24th day of JULY A.D., 2023 , before me personally came **Gary W. Stumper** to me known, who, being by me duly sworn, did depose and say, that he resides in **Medina, OH**; that he is **National Surety Leader and Senior Executive** of WESTFIELD INSURANCE COMPANY, WESTFIELD NATIONAL INSURANCE COMPANY and OHIO FARMERS INSURANCE COMPANY, the companies described in and which executed the above instrument; that he knows the seals of said Companies; that the seals affixed to said instrument are such corporate seals; that they were so affixed by order of the Boards of Directors of said Companies; and that he signed his name thereto by like order.

Notarial
Seal
Affixed



David A. Kotnik, Attorney at Law, Notary Public
My Commission Does Not Expire (Sec. 147.03 Ohio Revised Code)

State of Ohio
County of Medina ss.:

I, **Frank A. Carrino**, Secretary of WESTFIELD INSURANCE COMPANY, WESTFIELD NATIONAL INSURANCE COMPANY and OHIO FARMERS INSURANCE COMPANY, do hereby certify that the above and foregoing is a true and correct copy of a Power of Attorney, executed by said Companies, which is still in full force and effect; and furthermore, the resolutions of the Boards of Directors, set out in the Power of Attorney are in full force and effect.

In Witness Whereof, I have hereunto set my hand and affixed the seals of said Companies at Westfield Center, Ohio, this 2nd day of January A.D., 2024



Frank A. Carrino, Secretary

Pulled - No Legislative Action

received
12-29-23 915A

Item No. B.-7.

CITY OF OTTUMWA

Staff Summary

**** ACTION ITEM ****

Council Meeting of: Jan 2, 2024

Planning & Development
Department

Zach Simonson
Prepared By
Zach Simonson
Department Head



City Administrator Approval

AGENDA TITLE: Resolution No. 9-2024 Resolution Fixing Date for a Public Hearing on the Proposal to Renew the Downtown Ottumwa Self-Supporting Municipal Improvement District

Public hearing required if this box is checked.

RECOMMENDATION: Pass and adopt Resolution No. 9-2024

DISCUSSION: A petition has been timely filed and which fulfills the requirements of Chapter 386 of the Code of Iowa to renew the Downtown Self-Supporting Municipal Improvement District. This resolution sets January 2, 2024 as the date of a public hearing to consider renewing the district for a further 7 years. This hearing was previously meant to be January 2, however Code requires a letter to be sent to all property owners in the proposed district.

Source of Funds:

Budgeted Item: Budget Amendment Needed:

That notice was not sent before January 2. It has now been sent for the January 16 date.

RESOLUTION NO. 9-2024

RESOLUTION FIXING DATE FOR A PUBLIC HEARING ON
THE PROPOSAL TO RENEW THE DOWNTOWN OTTUMWA
SELF-SUPPORTING MUNICIPAL IMPROVEMENT DISTRICT

WHEREAS, pursuant to the provisions of Chapter 386 of the Code of Iowa (the “Act”), a petition has been filed with the City Clerk of the City of Ottumwa and presented to this Council (the “Petition”), which petitions this Council to renew the Downtown Ottumwa Self-Supporting Municipal Improvement District (the “Proposed District”), and to continue the Operation Fund for the Proposed District and continue to levy an annual tax therefor, all in accordance with and pursuant to the Act; and

WHEREAS, the Petition contains the signatures of at least twenty-five per cent (25%) of all owners of the property within the Proposed District; and

WHEREAS, the Petition contains the signatures of owners representing ownership of property with an assessed value equal to twenty-five per cent (25%) or more of the assessed value of all the property within the Proposed District; and

WHEREAS, the property to be included in the Proposed District pursuant to the Petition is contiguous, wholly within the boundaries of the City, and is in districts zoned for commercial uses; and

WHEREAS, the Plan and Zoning Commission for the City of Ottumwa has provided its recommendation to renew the Downtown Self-Supporting Municipal Improvement District; and

NOW THEREFORE, BE IT RESOLVED, BY THE CITY COUNCIL OF THE CITY OF OTTUMWA IN THE STATE OF IOWA:

Section 1. That this Council meet in the Bridge View Center, 102 Church Street, Ottumwa, Iowa, at 5:30 P.M. on January 16, 2024, for the purpose of taking action on Ordinance No. 3221-2024 renewing the Downtown Ottumwa Self-Supporting Municipal Improvement District.

Section 2. That the City Clerk is hereby directed to cause at least one publication to be made of a notice of said meeting, in a legal newspaper, printed wholly in the English language, published at least once weekly, and having general circulation in said City, said publication to be not less than four (4) clear days nor more than twenty (20) days before the date of said public meeting.

Section 3. The notice of the proposed action shall be in substantially the following form:

(One publication required)

NOTICE OF PUBLIC HEARING OF THE CITY COUNCIL OF THE
CITY OF OTTUMWA IN THE STATE OF IOWA, ON THE MATTER
OF THE PROPOSAL TO RENEW THE DOWNTOWN
OTTUMWA SELF-SUPPORTING MUNICIPAL
IMPROVEMENT DISTRICT, AND THE HEARING THEREON

NOTICE IS HEREBY GIVEN: There is now on file for public inspection in the office of the City Clerk of the City of Ottumwa, Iowa, a Petition asking the City Council to establish a Self-Supported Municipal Improvement District pursuant to Chapter 386 of the Code of Iowa (the" Act"), to be known as the Downtown Ottumwa Self-Supported Municipal Improvement District" (the" Proposed District").

The purposes for which the Proposed District is to be established shall be the undertaking of actions and the design and construction of any and all improvements authorized by the Act and the performance of administration, redevelopment and revitalization of the Proposed District, as authorized by the Act, any and all of which actions and improvements are intended to benefit the property within the Proposed District. General priorities set out in the Petition include enhanced maintenance and cleaning of public spaces in the Proposed District, development and management of activities in support of marketing, business retention and attraction, and capital, physical or other improvements designed to enhance the image and appearance of the Proposed District.

A consolidated description of the property within the Proposed District is as follows:

All property from the intersection of N. Marion Street and W. 4th Street, east to N. Market Street, south to E. 3rd Street, east to N. Jefferson Street, south to the river, west to the south of Marion Street, north to W. 4th Street, including one property at 302 W. Main Street west of Marion Street.

The Petition also provides for the establishment of a Self-Supported Municipal Improvement District Operation Fund and the levy of an annual tax with respect to such fund upon all the property, as defined in the Act, within the Proposed District, excluding property assessed as residential property for property tax purposes, for a period of five fiscal years, starting with the fiscal year that will begin on July 1, 2019, and continuing for four additional years. The Petition divides the property in the Proposed District into three zones, and the maximum rates of tax that may be levied in any year shall not exceed 1.00 per thousand dollars of taxable value of Property in Zone 1, \$ 2.00 per thousand dollars of taxable value of property in Zone 2 and \$ 3.00 per thousand dollars of taxable value of property in Zone 3.

The City Council will meet on the 16th day of January, 2019, at 5:30 o' clock p.m. at the Bridge View Center, 102 Church St., Ottumwa, Iowa, for the purpose of holding a hearing and taking action on the establishment of the Proposed District. At that time and place, the City Council will hear all owners of property in the Proposed District or residents of the City desiring to express their views with respect to the establishment of the Proposed District.

This notice is given by order of the City Council of the City of Ottumwa in the State of Iowa, as provided by Section 362.3, Code of Iowa.

Dated this 2nd day of January, 2024.

City Clerk, City of Ottumwa in the State of Iowa

(End of Notice)

PASSED AND APPROVED this 2nd day of January, 2024.

Mayor

ATTEST:

City Clerk

received
12-29-2023 915A

Item No. H.-1.

CITY OF OTTUMWA

Staff Summary

**** ACTION ITEM ****

Council Meeting of: Dec 2, 2024

Planning & Development
Department

Zach Simonson
Prepared By
Zach Simonson
Department Head



City Administrator Approval

AGENDA TITLE: Report on Bird E-Scooter Program

 Public hearing required if this box is checked.

RECOMMENDATION: No action necessary, staff seeks direction from the Council on possible renewal of e-scooter program with Bird.

DISCUSSION: The City of Ottumwa has had an agreement with Bird to grant a license to use the public right-of-way for their e-scooter program. That agreement is up for possible renewal this year. Bird filed for Chapter 11 bankruptcy on December 20, 2023. Staff has been in contact with employees at Bird and they have assured the City that operations are continuing as the company is up for potential sale or acquisition.

Source of Funds:

Budgeted Item: Budget Amendment Needed:

As part of operations continuing as usual, Bird has indicated they do seek to renew the existing agreement. For now, staff is seeking general direction from the Council about the e-scooter program. There are at least three possible directions forward:

- Renew the agreement with Bird and continue to work with an any successor company;
- Release an RFQ to identify any other parties which would seek the e-scooter license for Ottumwa;
- Stop the e-scooter program in Ottumwa indefinitely.

If the Council wishes to continue the program, staff would recommend continuing with Bird for now and will present an updated agreement a future meeting. There is no royalty paid to the City for the program or any cost borne by the City. Bird has provided adequate response to calls for service and there seems to be little reason to change operators if we are to continue with the program.

received
12-29-23 1130A

Business

CITY OF OTTUMWA
Staff Summary

**** ACTION ITEM ****

Council Meeting of: 1/2/24

Fire
Department

Pat Short
Prepared By
Pat Short
Department Head

Pat Kelly
City Administrator Approval

AGENDA TITLE: Authorize purchase of a new fire apparatus for the fire dept.

RECOMMENDATION: To approve this purchase from Sutphen Corporation for the price of \$869,400.34.

DISCUSSION: This is for the replacement of truck #308. This truck is a 1996 Pierce aerial with a 65 foot aerial. The aerial device was taken out of service approximately four years ago due to corrosion. The rear frame of #308 also has significant corrosion. This replacement was approved by fleet committee on 10/18/23. The price of replacement is \$869,400.34. This price is set to increase to approximately \$930,000 on January first. It will increase quarterly after that. Last year this truck increased 8% in a six month period.



PROPOSAL

TO THE:
Ottumwa Fire Department
Attn: Pat Short
201 N Wapello St
Ottumwa, IA

DATE: December 28th, 2023

We hereby propose and agree to furnish the following firefighting equipment upon your acceptance of this Proposal:

**One (1) Sutphen Custom Pumper Demo (G9- HS8039) Complete and Delivered for
the Total Sum of \$ 869,400.34**

The apparatus and equipment being purchased hereunder shall be completed within approximately 10 months after Sutphen's receipt and approval of Purchaser's acceptance of this Proposal.

This Proposal shall be valid for thirty (15) days. If a Purchase Agreement or Purchase Order is not received by Sutphen within 15 days of the date of this Proposal, Sutphen reserves the right to extend, withdraw, or modify this Proposal, including pricing, delivery times, and prepayment discounts, as applicable.

Respectfully submitted,

Ben Brown

Legacy Fire Apparatus
Authorized Representative for Sutphen Corporation

(877)374-0353



received
12-29-2023 9:15 AM

Item No. I.-1.

CITY OF OTTUMWA

Staff Summary

**** ACTION ITEM ****

Council Meeting of: Dec 2, 2024

Planning & Development
Department

Zach Simonson
Prepared By
Zach Simonson
Department Head



City Administrator Approval

AGENDA TITLE: Resolution No. 2-2024 Establishing Electrical Permit Fees for Wiring Statement Inspections in the City of Ottumwa, Iowa.

Public hearing required if this box is checked.

RECOMMENDATION: Pass and adopt Resolution No. 2-2024

DISCUSSION: Building Inspectors are called upon, from time to time, to conduct wiring statement inspections. These are inspections where no work has been done which would require a permit, but where the utility company requires a statement that the electrical system is safe to energize. These are most frequently necessary when a service has been voluntarily or involuntarily disconnected and requires reconnection.

Source of Funds:

Budgeted Item: Budget Amendment Needed:

Because there is no required permit, there has been no way of recovering the cost of inspectors' time in conducting these inspections. However, the inspection itself is general as thorough as the inspection for a new service and can often be more thorough than that, requiring investigation of entire circuits and more. This resolution would establish a \$20 fee for wiring statement inspections. For comparison, the fee for a new electrical service inspection would start at \$37.00.

Assessing a fee and running wiring statement inspections through the permitting process and the iWorQ software will also enable the City to keep better records of wiring statement inspections.

RESOLUTION NO. 2-2024

A RESOLUTION ESTABLISHING ELECTRICAL PERMIT FEES FOR WIRING STATEMENT INSPECTIONS IN THE CITY OF OTTUMWA, IOWA

WHEREAS, the Municipal Code of the City of Ottumwa, Iowa provides for the issuance of electrical permits with the fee therefore to be established by resolution of the City Council; and

WHEREAS, Resolution 101-2010 established electrical permit fees; and

WHEREAS, inspectors are called upon from time to time to conduct electrical wiring statement inspections to reenergize a disconnected electrical service where no other work has been done;

WHEREAS, wiring statement inspections still require inspectors' time and expertise;

NOW, THEREFORE, BE IT RESOLVED BY THE CITY COUNCIL OF THE CITY OF OTTUMWA, IOWA:

The fee for Electrical Wiring Statement inspections be set at \$20.00 per inspection.

Approved, passed and adopted this 2nd of January, 2024.

CITY OF OTTUMWA, IOWA

BY

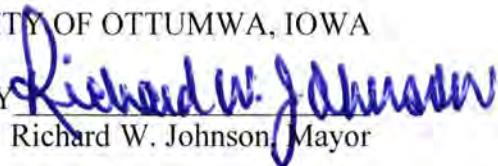
Richard W. Johnson, Mayor

ATTEST:

Chris Reinhard, City Clerk



received
12-29-23 915A

Item No. I.-2.

CITY OF OTTUMWA

Staff Summary

**** ACTION ITEM ****

Council Meeting of: January 2, 2024

Phillip Burgmeier

Prepared By

Phillip Burgmeier
Department Head

Engineering
Department

P. P. R. R.
City Administrator Approval

AGENDA TITLE: Resolution #3-2024. Awarding the contract for the Blake's Branch Phase 8, Division II Sewer Separation Project Ottumwa, Iowa.

**Public hearing required if this box is checked. **

The Proof of Publication for each Public Hearing must be attached to this Staff Summary. If the Proof of Publication is not attached, the item will not be placed on the agenda.

RECOMMENDATION: Pass and adopt Resolution #3-2024.

DISCUSSION: This project consists of extending Phase 8's 30" separated sanitary trunk pipe for 570' up the Blake's Branch watershed beginning at the end of Division I (intersection of Birch and Plum Streets) and ending 200' north of 4th Street. The project will also construct 2,700' of new sanitary sewer connected to the trunk line, and 3,800' of new separated storm sewers. OWW will be replacing old water mains within the streets disturbed for construction of new sewers. A total of 13,100 SY of streets and 4,500 SY of driveways and sidewalks will be reconstructed.

Plans for the project are posted on the City's website, submitted to Master Builders of Iowa, Iowa Concrete Paving Association, and Iowa League of Cities for publication with their Construction Update plan services, and available for pick up in the Engineering Office. An announcement was published in the Ottumwa Courier notifying the public of the project.

Thirty-three (33) sets of Plans and Specifications were requested. Bids were received and opened by the City of Ottumwa on December 13, 2023 at 2:00 p.m. Four (4) bids were received. The low bidder is J & K Contracting, LLC of Urbandale, Iowa in the amount of \$5,716,345.00.

Bid Tab and Plan Holders List are attached.

Current construction estimate: \$5,100,000

Source of Funds:

\$2,500,000 STAG Grant

\$2,600,000 Sewer Fund Balance

(An estimated \$250,000 will be reimbursed by OWW for water main construction)

Source of Funds: STAG and Sewer Fund

Budgeted Item: No

Budget Amendment Needed: Yes

RESOLUTION #3-2024

A RESOLUTION AWARDING THE CONTRACT FOR THE
BLAKE'S BRANCH PHASE 8, DIVISION II SEWER SEPARATION PROJECT

WHEREAS, The City Council of the City of Ottumwa, Iowa did advertise and accept bids for the above referenced project; and,

WHEREAS, Bids were received, proper, and mathematically correct.

NOW, THEREFORE, BE IT RESOLVED, BY THE CITY COUNCIL OF THE CITY OF OTTUMWA, IOWA THAT: The award of contract for the above referenced project is made to the lowest responsible bidder, J & K Contracting, LLC of Urbandale, Iowa in the amount of \$5,716,345.00.

APPROVED, PASSED, AND ADOPTED, this 2nd day of January, 2024.

CITY OF OTTUMWA, IOWA

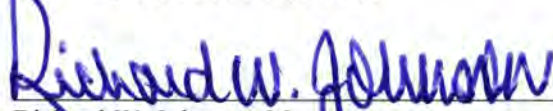
Richard W. Johnson, Mayor

ATTEST:

Christina Reinhard, City Clerk



VEENSTRA & KIMM INC.

3000 Westown Parkway
West Des Moines, Iowa 50266

515.225.8000 // 800.241.8000
www.v-k.net

December 14, 2023

Phillip Burgmeier
Public Works Director
City of Ottumwa
105 East Third Street
Ottumwa, Iowa 52501

CITY OF OTTUMWA, IOWA
BLAKE'S BRANCH SEWER SEPARATION, PHASE 8, DIVISION 2,
4th STREET SEWER SEPARATION
REVIEW OF BIDS RECEIVED
RECOMMENDATION TO AWARD CONTRACT

The City of Ottumwa received bids until 2:00 P.M. on December 13, 2023 for the Blake's Branch Sewer Separation, Phase 8, Division 2, 4th Street Sewer Separation project. A total of four bids were received as follows:

<u>Contractor</u>	<u>Total Bid</u>
J&K Contracting, LLC	\$5,716,345.00
Drish Construction, Inc.	\$6,142,010.00
Rognes Corporation	\$7,464,586.00
McCarthy Improvement Company	\$8,151,550.00

The low bid for the project was submitted by J&K Contracting, LLC of Urbandale, Iowa. Veenstra & Kimm noted Rognes Corporation had one math error on the extended price for a bid item resulting in an increase of \$9,795.00 of their bid. The correction of the math error did not change the ranking of Contractors submitting bids for the project.

The Engineers Estimate of cost for the project was \$5,100,000.00. The low bid received was \$5,716,345.00 or approximately 12% over the Engineer's Estimate. The average of the four bids received was approximately \$6,868,622.75.

A couple of factors appear to contribute to the high bids received for the project as compared to recent bidding history for similar type of work. The project was phased to ensure bus and school traffic routes are available for both the High School and Elementary Schools during construction

Phillip Burgmeier, P.E.

December 14, 2023

Page 2

of the project. The project phases restricted the Contractor to work in approximately two City block sections. The short sections of the project may have contributed to a higher paving price as the contractor may not be able to be as efficient for longer sections of street paving. Also, material costs continue to be much higher than normal and the availability of materials may create issues with meeting project schedules.

After review of the bids received, Veenstra & Kimm, Inc. would recommend the City of Ottumwa award contract for project to J&K Contracting, LLC in the amount of \$5,716,345.00.

A copy of the bid tabulation is enclosed.

If you have any questions or comments concerning the project, please contact us at 515-225-8000.

VEENSTRA & KIMM, INC.



Randy M. Johnson, P.E.

40985

Enclosure

BID TABULATION
OTTUMWA, IOWA
BLAKE'S BRANCH SEWER SEPARATION, PHASE 8, DIVISION 2, 4TH STREET SEWER SEPARATION

1. Construct Blake's Branch Sewer Separation, Phase 8, Division 2 4th Street Separation project including all associated work for the following unit and lump sum prices:				J&K Contracting, LLC 10703 Justin Drive Urbandale, IA 50322		Drish Construction, Inc. 1701 S. Main Street Fairfield, IA 52556		Rognes Corporation 1609 N Ankeny Blvd, Ste 210 Ankeny, IA 50023		McCarthy Improvement Company 5401 Victoria Avenue Davenport, IA 52807	
ITEM NO.	DESCRIPTION	UNIT	ESTIMATED QUANTITY	UNIT PRICE	EXTENDED PRICE	UNIT PRICE	EXTENDED PRICE	UNIT PRICE	EXTENDED PRICE	UNIT PRICE	EXTENDED PRICE
1	Mobilization	LS	1	\$ 555,000.00	\$ 555,000.00	\$ 500,000.00	\$ 500,000.00	\$ 925,000.00	\$ 925,000.00	\$ 900,000.00	\$ 900,000.00
2	Traffic Control	LS	1	16,000.00	16,000.00	50,000.00	50,000.00	18,620.00	18,620.00	457,000.00	457,000.00
3	Construction Staking	LS	1	43,000.00	43,000.00	43,250.00	43,250.00	48,900.00	48,900.00	50,000.00	50,000.00
4	Maintenance of Solid Waste Collection	LS	1	9,000.00	9,000.00	13,000.00	13,000.00	12,410.00	12,410.00	50,000.00	50,000.00
5	Trench Compaction Testing	LS	1	26,000.00	26,000.00	17,125.00	17,125.00	31,030.00	31,030.00	200,000.00	200,000.00
6	Pavement Samples & Testing	LS	1	21,000.00	21,000.00	16,000.00	16,000.00	9,310.00	9,310.00	25,000.00	25,000.00
7	Clearing and Grubbing	LS	1	75,000.00	75,000.00	26,100.00	26,100.00	31,030.00	31,030.00	65,000.00	65,000.00
8	Chain Link Fence, Removal and Replacement	LF	100	35.00	3,500.00	56.50	5,650.00	186.00	18,600.00	55.00	5,500.00
9	Excavation, Class 10	CY	2,500	25.00	62,500.00	33.15	82,875.00	33.00	82,500.00	60.00	150,000.00
10	Rock Excavation	CY	200	245.00	49,000.00	75.65	15,130.00	279.00	55,800.00	150.00	30,000.00
11	Off-Site Borrow Material	CY	200	35.00	7,000.00	58.50	11,700.00	33.00	6,600.00	12.00	2,400.00
12	Stabilization Material	TON	200	30.00	6,000.00	78.00	15,600.00	72.00	14,400.00	50.00	10,000.00
13	Subgrade Preparation	SY	15,000	5.00	75,000.00	3.20	48,000.00	5.00	75,000.00	3.00	45,000.00
14	Modified Subbase, 6"	SY	15,000	10.00	150,000.00	12.50	187,500.00	13.00	195,000.00	14.00	210,000.00
15	Granular Surfacing, 6"	TON	450	35.00	15,750.00	41.50	18,675.00	38.00	17,100.00	40.00	18,000.00
16	Pavement Removal	SY	13,500	10.00	135,000.00	9.00	121,500.00	16.00	216,000.00	13.00	175,500.00
17	Sidewalks and Driveways Removal/Disposition	SY	5,000	10.00	50,000.00	7.00	35,000.00	13.00	65,000.00	14.00	70,000.00
18	Pavement, PCC, 8", Integral Curb	SY	13,500	90.00	1,215,000.00	87.00	1,174,500.00	90.00	1,215,000.00	100.00	1,350,000.00
19	PCC Driveway, 6", Type A	SY	1,250	85.00	106,250.00	90.00	112,500.00	85.00	106,250.00	120.00	150,000.00
20	Sidewalk, PCC, 4"	SY	2,900	85.00	246,500.00	90.00	261,000.00	82.00	237,800.00	95.00	275,500.00
21	Detectable Warning Panels	SF	528	70.00	36,960.00	60.00	31,680.00	70.00	36,960.00	65.00	34,320.00
22	Epoxy Coated Pavement Reinforcement	LBS	38,740	1.75	67,795.00	1.00	38,740.00	1.75	67,795.00	1.50	58,110.00
23	Pipe Removal, 6" - 36"	LF	4,200	25.00	105,000.00	50.00	210,000.00	38.00	159,600.00	36.00	151,200.00
24	Sewer Removal, 4th Street Brick Box	LF	830	40.00	33,200.00	50.00	41,500.00	76.00	63,080.00	150.00	124,500.00
25	Sewer Abandonment, Box, Fill and Plug	CY	110	340.00	37,400.00	265.00	29,150.00	303.00	33,330.00	450.00	49,500.00
26	Removal Manhole	EA	11	1,000.00	11,000.00	1,500.00	16,500.00	1,515.00	16,665.00	750.00	8,250.00
27	Remove Intake Structure	EA	33	1,000.00	33,000.00	1,500.00	49,500.00	1,515.00	49,995.00	750.00	24,750.00
28	Storm Sewer, 12" Trenchless	LF	160	260.00	41,600.00	160.00	25,600.00	259.00	41,440.00	180.00	28,800.00
29	Storm Sewer, 12" Class 5 RCP, Trenched	LF	360	70.00	25,200.00	102.00	36,720.00	136.00	48,960.00	80.00	28,800.00
30	Storm Sewer, 15" Class 5 RCP, Trenched	LF	1,580	80.00	126,400.00	110.00	173,800.00	142.00	224,360.00	110.00	173,800.00
31	Storm Sewer, 18" Class 5 RCP, Trenched	LF	310	95.00	29,450.00	200.00	62,000.00	149.00	46,190.00	130.00	40,300.00
32	Storm Sewer, 36" Class 4 RCP, Trenched	LF	92	180.00	16,560.00	331.00	30,452.00	296.00	27,232.00	375.00	34,500.00
33	Storm Sewer, 42" Class 4 RCP, Trenched	LF	174	240.00	41,760.00	350.00	60,900.00	374.00	65,076.00	500.00	87,000.00
34	Storm Sewer, 48" Class 4 RCP, Trenched	LF	914	275.00	251,350.00	375.00	342,750.00	436.00	398,504.00	525.00	479,850.00
35	Storm Sewer, Connect Pipe at Existing Box	EA	2	6,500.00	13,000.00	9,500.00	19,000.00	3,925.00	7,850.00	4,500.00	9,000.00
36	Storm Sewer, Connect Pipe at Existing Structure	EA	1	6,500.00	6,500.00	5,000.00	5,000.00	3,925.00	3,925.00	3,000.00	3,000.00
37	Storm Sewer Manhole SW-401, 48" Dia.	EA	1	6,000.00	6,000.00	5,300.00	5,300.00	5,545.00	5,545.00	5,500.00	5,500.00
38	Storm Sewer Manhole SW-401, 60" Dia.	EA	1	9,000.00	9,000.00	7,500.00	7,500.00	8,760.00	8,760.00	6,500.00	6,500.00
39	Storm Sewer Manhole SW-401, 72" Dia.	EA	1	14,000.00	14,000.00	16,100.00	16,100.00	15,610.00	15,610.00	14,000.00	14,000.00
40	Storm Sewer Manhole SW-401, 96" Dia.	EA	4	22,000.00	88,000.00	25,000.00	100,000.00	28,370.00	113,480.00	21,000.00	84,000.00
41	Storm Sewer Intake, SW-501	EA	19	4,500.00	85,500.00	6,050.00	114,950.00	4,575.00	86,925.00	5,500.00	104,500.00
42	Storm Sewer Intake, SW-503	EA	2	7,000.00	14,000.00	7,450.00	14,900.00	7,405.00	14,810.00	6,000.00	12,000.00
43	Storm Sewer Intake, SW-505	EA	13	9,200.00	119,600.00	9,200.00	119,600.00	9,795.00	127,335.00	8,500.00	110,500.00
44	Storm Sewer Intake, SW-511, 36" x 36" I.D.	EA	1	3,600.00	3,600.00	5,000.00	5,000.00	4,580.00	4,580.00	4,700.00	4,700.00
45	Storm Sewer Intake, SW-512, 24" Dia.	EA	1	4,000.00	4,000.00	3,650.00	3,650.00	4,050.00	4,050.00	2,300.00	2,300.00
46	Storm Sewer Subdrain, 6"	LF	7,350	22.00	161,700.00	16.30	119,805.00	32.00	235,200.00	20.00	147,000.00
47	Storm Sewer Subdrain Outlets	EA	33	450.00	14,850.00	400.00	13,200.00	536.00	17,688.00	250.00	8,250.00

**BID TABULATION
OTTUMWA, IOWA
BLAKE'S BRANCH SEWER SEPARATION, PHASE B, DIVISION 2, 4TH STREET SEWER SEPARATION**

1. Construct Blake's Branch Sewer Separation, Phase 8, Division 2 4th Street Separation project including all associated work for the following unit and lump sum prices:			J&K Contracting, LLC 10703 Justin Drive Urbandale, IA 50322		Drish Construction, Inc. 1701 S. Main Street Fairfield, IA 52556		Rognes Corporation 1609 N Ankeny Blvd, Ste 210 Ankeny, IA 50023		McCarthy Improvement Company 5401 Victoria Avenue Davenport, IA 52807		
ITEM NO.	DESCRIPTION	UNIT	ESTIMATED QUANTITY	UNIT PRICE	EXTENDED PRICE	UNIT PRICE	EXTENDED PRICE	UNIT PRICE	EXTENDED PRICE	UNIT PRICE	EXTENDED PRICE
48	Storm Sewer Subdrain Cleanouts	EA	14	1,700.00	23,800.00	1,250.00	17,500.00	1,060.00	14,840.00	900.00	12,600.00
49	Sanitary Sewer Gravity Main, 8", Trenched	LF	1,920	100.00	192,000.00	156.00	299,520.00	203.00	389,760.00	205.00	393,600.00
50	Sanitary Sewer Gravity Main, 12", Trenched	LF	796	120.00	95,520.00	181.00	144,076.00	225.00	179,100.00	375.00	298,500.00
51	Sanitary Sewer Gravity Main, 15", Trenched	LF	54	150.00	8,100.00	208.00	11,232.00	326.00	17,604.00	230.00	12,420.00
52	Sanitary Sewer Gravity Main, 30", Trenched	LF	466	280.00	130,480.00	475.00	221,350.00	458.00	213,428.00	800.00	372,800.00
53	Sanitary Sewer Gravity Main, 36", Trenched	LF	56	320.00	17,920.00	665.00	37,240.00	819.00	45,864.00	800.00	44,800.00
54	Sanitary Sewer Manhole, Type SW-301, 48" Dia.	EA	14	8,000.00	112,000.00	11,600.00	162,400.00	16,980.00	237,720.00	9,000.00	126,000.00
55	Sanitary Sewer Manhole, Type SW-301, 60" Dia.	EA	2	25,000.00	50,000.00	35,000.00	70,000.00	27,010.00	54,020.00	25,000.00	50,000.00
56	Sanitary Sewer, Manhole, Type SW-301, 72" Dia.	EA	1	35,000.00	35,000.00	49,000.00	49,000.00	49,710.00	49,710.00	45,000.00	45,000.00
57	Sanitary Sewer, 8" External Drop Connection	EA	2	11,000.00	22,000.00	8,600.00	17,200.00	10,440.00	20,880.00	5,800.00	11,600.00
58	Sanitary Sewer, 12" External Drop Connection	EA	2	14,500.00	29,000.00	11,500.00	23,000.00	14,580.00	29,160.00	8,600.00	17,200.00
59	Sanitary Sewer Service Stub, 6", Trenched	LF	1,400	80.00	112,000.00	68.00	95,200.00	107.00	149,800.00	107.00	149,800.00
60	Sanitary Sewer Service Stub, 6", Trenchless	LF	500	245.00	122,500.00	74.00	37,000.00	169.00	84,500.00	83.00	41,500.00
61	Sanitary Sewer Service Connection	EA	39	1,200.00	46,800.00	1,410.00	54,990.00	1,865.00	72,735.00	400.00	15,600.00
62	Water Main Abandonment, Cap	EA	5	1,200.00	6,000.00	1,600.00	8,000.00	2,615.00	13,075.00	600.00	3,000.00
63	Water Main, 6", PVC, Trenched	LF	1,200	55.00	66,000.00	68.00	81,600.00	119.00	142,800.00	70.00	84,000.00
64	Water Main, 8", PVC, Trenched	LF	650	65.00	42,250.00	93.00	60,450.00	129.00	83,850.00	75.00	48,750.00
65	Water Main, 8", Trenchless	LF	50	215.00	10,750.00	125.00	6,250.00	255.00	12,750.00	225.00	11,250.00
66	Water Main Fittings, 4" to 12"	EA	25	1,000.00	25,000.00	705.00	17,625.00	1,130.00	28,250.00	825.00	20,625.00
67	Water Main, 8" Gate Valve	EA	2	3,100.00	6,200.00	2,800.00	5,600.00	3,230.00	6,460.00	3,100.00	6,200.00
68	Water Main, 6" Gate Valve	EA	4	2,500.00	10,000.00	2,100.00	8,400.00	2,235.00	8,940.00	2,500.00	10,000.00
69	Water Main, Hydrant Removal	EA	4	1,800.00	7,200.00	750.00	3,000.00	890.00	3,560.00	900.00	3,600.00
70	Water Main, Hydrant Assembly	EA	4	8,400.00	33,600.00	8,000.00	32,000.00	9,245.00	36,980.00	9,000.00	36,000.00
71	Water Main Reconnections	EA	9	3,000.00	27,000.00	3,900.00	35,100.00	3,490.00	31,410.00	2,000.00	18,000.00
72	1" Water Service Reconnection, Trenched	EA	30	4,300.00	129,000.00	2,800.00	84,000.00	4,120.00	123,600.00	3,800.00	114,000.00
73	Seeding, Fertilizing, and Mulching, Type 1	ACRE	3	6,500.00	19,500.00	4,250.00	12,750.00	5,585.00	16,755.00	5,500.00	16,500.00
74	Silt Fence, Install and Removal	LF	4,000	2.25	9,000.00	5.50	22,000.00	2.00	8,000.00	4.00	16,000.00
75	Filter Socks, 8", Install and Removal	LF	4,000	2.25	9,000.00	6.00	24,000.00	2.00	8,000.00	1.00	4,000.00
76	Erosion Control Mulching, Hydromulching	ACRE	3	2,500.00	7,500.00	3,500.00	10,500.00	4,345.00	13,035.00	3,500.00	10,500.00
77	Temporary Rolled Erosion Control (RECP)	SY	5,000	1.40	7,000.00	2.10	10,500.00	4.00	20,000.00	3.50	17,500.00
78	Stormwater Pollution Prevention Plan (SWPPP) Preparation	LS	1	5,000.00	5,000.00	2,000.00	2,000.00	6,205.00	6,205.00	6,000.00	6,000.00
79	Stormwater Pollution Prevention Plan (SWPPP) Management	LS	1	12,000.00	12,000.00	6,500.00	6,500.00	6,205.00	6,205.00	30,000.00	30,000.00
80	Stamped Concrete Crosswalk, PCC, 8"	SY	135	180.00	24,300.00	175.00	23,625.00	217.00	29,295.00	225.00	30,375.00
TOTAL BID ITEMS (Items 1 - 80)				\$5,716,345.00		\$6,142,010.00		7,454,791.00 \$7,464,586.00		\$8,151,550.00	

I hereby certify that this is a true tabulation of bids received on December 13, 2023 by the City of Ottumwa, Iowa.



Randy Johnson

Randy M. Johnson, P.E.
Iowa License No. 22407

My license renewal date is December 31, 2023

**VEENSTRA & KIMM INC.**3000 Westown Parkway
West Des Moines, Iowa 50266515.225.8000 // 800.241.8000
www.v-k.net**PLAN HOLDERS FOR:**Ottumwa, Iowa
Blake's Branch Sewer Separation, Phase 8,
Division 2, 4th Street Sewer Separation

Last Update: December 13, 2023

Engineer's Estimate: \$4,750,000
Bids Received: 2:00 P.M., Wednesday, December 13, 2023**CONTRACTORS**County Materials Corporation
270 Izaak Walton Road
Iowa City, IA 52246
319-358-6960 Phone
tara.odonnell@countymaterials.comConcrete Technologies Inc.
1001 SE 37th Street
Grimes, IA 50111
Phone: 5152521650
hdiaz@cti-ia.comMcAninch Corp.
100 E Grand
Suite 350
Des Moines, IA 50309
515-267-2567 Phone
ckinzie@mcaninchcorp.comLangman Construction, Inc.
220 34th Avenue
Rock Island, IL 61201
563-529-5040 Phone
309-786-2107 Fax
brian@langmanco.comDC Concrete & Construction, LLC
15479 Emerald Rd
Douds, IA 52551-8104
641-919-0636 Phone
dcconstruction.ia@gmail.comS.M. Hentges & Sons, Inc.
3230 99th Street
Urbandale, IA 50322
612-505-6080 Phone
952-492-5705 Fax
john.klein@smhentges.comJ Pettiecord Inc.
1200 Prairie Dr SW
Bondurant, IA 50035
515-263-8900 Phone
laramie@jpettiecord.comWarner Engineering Associates Inc.
1010 E. Washington St., Suite 202
Mount Pleasant, IA 52641
Phone: 319-385-4180
Email: jwarner@warneriowa.comLeffler Dirtworks
2272 320th Street
Oskaloosa, IA 52577
641-226-2231
cleffler44@gmail.comFloorcoat Midwest, LLC
P.O. Box 172
Arnolds Park, IA 51331
507-327-5545
floorcoatmidwest@gmail.comJones Contracting Corp.
P.O. 156
West Point 52656
319-837-8129
tsummers@jonescontractingcorp.comS.J. Louis Construction, Inc.
P.O. Box 459
Rockville, MN 56369
320-253-9291 Phone
320-529-4020 Fax
savannahj@silouis.com

Manatts
1775 Old 6 Road
P.O. Box 535
Brooklyn, IA 52211
641-522-9206 Phone
641-522-5594 Fax
tylerb@manatts.com

Drish Construction
17017 S. Main
Fairfield, IA 52556
dayle.drish@gmail.com

JQ Construction, LLC
313 Pine Street
Washburn, IA 50702
319-269-5518
jqconstruction@live.com

Iowa Civil Contracting
1106 3rd St. P.O. Box Q
Victor, IA 52347
P:319-647-3561 ext. 140
F:319-647-2376
missyr@iowacivil.com

Fye Excavating, Inc.
10165 Sperry Road
Sperry, IA 52650
fye@fyeexcavating.com

Rognes Corporation
1609 N Ankeny Blvd
Suite 210
Ankeny, IA 50023
515-965-0030 Phone
crognes@rognescorp.com

Jet Drain Excavating Services
1608 Crestwood Circle
Ames, IA 50010
515-231-9963 Phone
chase@jetdrainiowa.com

McCarthy Improvement
5401 Victoria Avenue
Davenport, IA 52807
563-344-3708 Phone
563-594-9284 Cell
563-441-2165 Fax
jduarte@mccarthyimprovement.com

Cornerstone Excavating Inc.
1320 W Main Street
P.O. Box 928
Washington, IA 52353
office@cstoneinc.com

Selco Inc.
210 Second Street
East Dubuque, IL 61025
563-556-2434 Phone
563-556-2436 Fax
selcoinc@mchsi.com

TK Concrete, Inc.
1608 Fifield Road
Pella, IA 50219
641-628-4590 Phone
641-628-0064 Fax
jen@vermeergroup.com

Wicks Construction, Inc.
PO Box 428
Decorah, Iowa 52101
563-382-2325 Phone
dave@wicksconstruction.com

Concrete Technologies, Inc.
1001 SE 37th Street
Grimes, IA 50111
515-252-1650 Phone
515-252-1642 Fax
hdiaz@cti-ia.com

Jackson Contracting Group
3409 Brook Ridge Ct
Des Moines, IA 50317
515-306-4487
jacksoncontractinggroup@gmail.com

The Driller LLC
5125 East University Ave
Pleasant Hill, IA 50327
515-266-2261 Phone
suebush@thedrillerllc.com

Eslinger Contracting
2500 R63 Hwy
Norwalk, IA 50211
515-202-3605
scott@eslingercontracting.com

Evolution Contracting
PO Box 160
Indianola, IA 50125
515-322-2860 Phone
j.mrzena@eciowa.com

Visu-Sewer, Inc.
W230 N4855 Betker Drive
Pewaukee, WI 53072
262-695-2340 Phone
262-695-2359 Fax
estimating@visu-sewer.com

KLC Construction LLC
Kent Loynachan
2235 Payton Road
Corydon, IA 50060
641-203-2081 Phone
KLCCConst@yahoo.com

J&K Contracting
10703 Justin Drive
Urbandale, IA 50322
515-233-5500 Phone
515-278-2351 Fax
jared@jkcia.com

Service Signing, LC
PO Box 158
Cedar Falls, IA 50613
319-235-9356 Phone
allison@servicesigning.com

Boyle Built Enterprises, LLC
33838 142nd Street
Selma, IA 52588
Phone: 641-777-3133
Email: amy@boylebuilt.com

SKOL Trucking
5421 NW Beaver
Johnston, IA 50131
515-474-4301
scott@skoltrucking.com

SUPPLIERS

HOBAS Pipe
1413 E. Richey Rd.
Houston, TX 77073
281-821-2200 Phone
cmunk@hobaspipe.com

Lincoln WinWater Company
515 NW 27th Street, Suite 2
Lincoln, NE 68528
402-438-2988 - Phone
sjenger@winwaterworks.com

Jason Bordewyk
13135 Danielson St Ste 201
Poway, CA 92064
651-775-5164
jbordewyk@aegion.com

Construction Materials, Inc.
5210 NE 17th Street
Des Moines, IA 50313
319-366-6446
ckoppes@constructionmaterialsinc.com

ASSOCIATION/PLAN ROOMS

Master Builders of Iowa
221 Park Street
Des Moines, Iowa 50309
515-288-7339 Phone
515-288-8718 Fax
[mbiplanroom-
dsm@mbionline.com](mailto:mbiplanroom-dsm@mbionline.com)

French Reneker Associates Inc.
1501 S Main Street
Fairfield, IA 52556
641-472-5145 Phone
jasonh@french-reneker.com

Iowa League of Cities
500 SW 7th Street, Suite 101
Des Moines, IA 50309
515-244-7282 Phone
978-367-9733 Fax
mailbox@iowaleague.org

Iowa Concrete Paving Association
360 SE Delaware
Ankeny, IA 50021
rbangs@concretestate.org



CITY OF OTTUMWA Staff Summary

**** ACTION ITEM ****

Council Meeting of : Jan 2, 2024

Philip Rath

Prepared By

Administration

Department

Department Head

City Administrator Approval

AGENDA TITLE: Resolution No. 5-2024 - A Resolution to Accept the Proposed Extension from Ahlers and Cooney, PC for the Provision of General Legal Services

Public hearing required if this box is checked.

RECOMMENDATION: Pass and adopt Resolution 5-2024

DISCUSSION: In 2020 the city moved to contracted legal services following the retirement of the former City Attorney. City staff prepared a Request For Proposals (RFP) and the City Council interviewed three firms, ultimately contracting with Ahlers and Cooney, PC via resolution 230-2020. The relationship is working well and is recommended to continue for the next cycle (2024 - 2025). A copy of the engagement letter is attached for review and approval. As with resolution 230-2020, staff is requesting discretion to utilize other legal firms as necessary based upon potential conflict of interest issues, access, and / or efficiency.

Source of Funds: N/A

Budgeted Item: Budget Amendment Needed:

RESOLUTION NO. 5-2024

**RESOLUTION ACCEPTING THE ENGAGEMENT AGREEMENT
FROM AHLERS & COONEY, PC
FOR THE PROVISION OF GENERAL LEGAL SERVICES**

WHEREAS, on October 20, 2020 the City of Ottumwa adopted Resolution 230-2020 a “Resolution Accepting the Proposal From Ahlers & Cooney, P.C. for the Provision of General Legal Services”; and

WHEREAS, the initial Engagement Agreement was for the years 2020-2021; and

WHEREAS, an updated Engagement Agreement addressing the years 2024-2025 has been prepared by Ahlers & Cooney, PC.

NOW, THEREFORE, BE IT RESOLVED, BY THE CITY COUNCIL OF THE CITY OF OTTUMWA, IOWA, that approval of the attached General Legal Services Engagement Agreement for 2024-2025 is granted and that the Mayor and the City Clerk of the city of Ottumwa, Iowa, are hereby authorized and directed to execute said Agreement on behalf of the City.

BE IT FURTHER RESOLVED, that the City Council provides the City Administrator with discretion to utilize alternative law firms as necessary for specialized legal services or as resolution to potential conflicts of interest, and/or increased efficiency in the provision of legal services.

APPROVED, PASSED AND ADOPTED, this 2nd day of January, 2024.

CITY OF OTTUMWA, IOWA

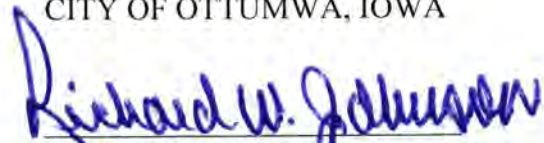
Richard W. Johnson, Mayor

ATTEST:

Christina Reinhard, City Clerk





Ahlers & Cooney, P.C.
Attorneys at Law

100 Court Avenue, Suite 600
Des Moines, Iowa 50309-2231
Phone: 515-243-7611
Fax: 515-243-2149
www.ahlerslaw.com

Kristine Stone
515.246.0314
kstone@ahlerslaw.com

December 28, 2023

Mayor and City Council
c/o Philip Rath
City of Ottumwa
105 East Third Street
Ottumwa, IA 52501

Sent via email only

RE: General Legal Services Engagement Agreement 2024-2025

Dear Mayor Johnson & City Council Members:

The purpose of this Engagement Agreement ("Agreement") is to disclose and memorialize the terms and conditions under which Ahlers & Cooney, P.C. (the "Firm") will represent the City of Ottumwa (the "City") in connection with certain general legal services generally described herein. The parties agree that Kristine Stone will be primarily responsible for serving as City Attorney and Logan Brundage and / or other attorneys of the Firm may assist Ms. Stone, when necessary.

SCOPE OF ENGAGEMENT

Upon request of the Mayor, City Council or City Administrator, the Firm will provide legal direction, advice, counsel, training, consultation, and opinions on all forms of City business including, but not limited to, the following services:

1. Advise and assist in the preparation of ordinances, orders, resolutions and regulations.
2. Prepare and pass on the legality and correctness and form of contracts, performance and other required bonds pursuant to City Code, and other legal instruments and documents.
3. Advise the City Council and all department heads and other administrative officials of the City as to the legality of any proposed action.
4. Be responsible for all prosecutions under the City Code or other ordinances of the City.
5. Represent the City as attorney in all legal proceedings in which the City is a party before any court or any judicial administrative or other body, including legal proceedings in which the City has retained special counsel to assist in the representation of the City.

6. Settle or compromise claims for suits at law or in equity in which the City may be a party, either by judgement entry or otherwise, subject to such procedures as the City Council may establish.
7. Preserve in its office copies of all written opinions given by the office.
8. Perform such other duties as may be required by state law or by the City Council.
9. Have a member of the Firm in attendance at all meetings of the City Council, except when excused. Such attendance may be by phone or other electronic means as the City may approve.
10. Recommend to the City Council when it is advisable to hire special counsel to represent or assist in the representation of the City in legal proceedings or in the preparation of legal documents or performing other legal services required of the office.

FEES

In calendar years 2024-2025 ("Term"), the Firm will charge a 5% discounted rate from the responsible attorney's standard hourly rate for work performed for the "standard city attorney services" enumerated in items 1-10 above. The Firm will charge its standard hourly rates on any particular assignment beyond the scope of the "standard city attorney services" identified herein. Effective January 1, 2024, Ms. Stone's hourly rate is \$300 per hour, and Mr. Brundage's rate is \$220 per hour. Rates are reviewed and may be adjusted in January of each year.

The Firm agrees to charge a discounted rate of \$200 per hour for travel time and for attendance at City Council meetings and other City Board meetings. The Firm will charge its standard hourly rates on any particular assignment beyond the scope of the "standard city attorney services" identified herein. After the Term, all rates shall be subject to mutual agreement between the parties.

The scope of this Agreement is limited to those services expressly set forth above. Absent a separate engagement agreement regarding one or more of the following services, our duties under this Agreement do **not** include:

1. Any litigation the Firm determines is beyond the scope of standard city attorney services;
2. Any labor negotiations, employment related hearings, including arbitrations, grievance hearings, fact-finding hearings, and disciplinary hearings;
3. Any eminent domain;
4. Significant land use projects;
5. Telecommunications;
6. Bond counsel and specialized finance services;
7. Regulatory and administrative hearings before other public agencies;
8. Public improvement contract advice, proceedings, contract review and negotiation;
9. Defending any legal challenges to or arising out of a particular public improvement project;

10. Any urban renewal or economic development related legal services;
11. Services related to electrical power supply or transmission services; and
12. Any other legal services not identified herein.

The parties acknowledge the City and the Firm have existing engagement agreements for urban renewal, economic development, labor, and bond (finance) related services, separate from this Agreement. The City Council may limit or expand the scope of this Agreement from time to time, provided that any such proposed modification is agreed to in writing by our Firm.

There may be situations that arise from time to time where unique circumstances or activities may warrant the need to engage other attorneys or law firms in connection with the operations of the City of Ottumwa. To the extent the Firm recommends the City engage one or more additional attorneys or law firms, and the City approves such an engagement (prior approval of the City Council of such engagement being required), said engagement shall be between the City and said attorney or law firm.

BILLING MATTERS

The Firm will invoice the City on a monthly basis. The format for the statements will contain a description of the dates and a detailed description of the tasks performed, the professionals performing the tasks and the amount of time spent on the tasks, a summary of each professional's time and billing rate, total time, the total fees and an itemization of any expenses. The City will not be billed for time for preparation of such statements.

In addition, the Firm will bill the City for all expenses incurred on its behalf, such as deliveries and other related expenses. The Firm will not charge the City for photocopying expenses, except to the extent such expenses are incurred in connection with litigation matters. Payment is due and payable within thirty (30) days of receipt of the invoice.

If, for any reason, the City terminates the engagement governed by this Agreement, we will bill the City for the services rendered as of the date of termination based on the hourly rates of those who provided services. The fee charged by the Firm for this representation will be based in part on the current hourly rate of the person performing the service at the time services are performed. We will also bill you for all expenses we have incurred as outlined above.

ATTORNEY-CLIENT RELATIONSHIP

Upon execution of this Agreement, the City of Ottumwa will be our client and an attorney-client relationship will exist with the Firm with respect to services for which the City Council or City Administrator requests our assistance. Either party hereto may terminate this engagement for any reason or no reason upon prior written notice.

RECORDS

At the City's request, any documents furnished by the City will be returned promptly upon receipt of payment for outstanding fees and client charges. Original signed copies of all agreements and documents will be provided to the City at the time of execution thereof. Our own files, including lawyer work product, pertaining to the above-referenced engagement will be retained by us. For various reasons, including the minimization of unnecessary storage expenses, we reserve the right to dispose of any documents or other material retained by us after the termination of this engagement; provided, however, prior to disposition of such documents or other material, the Firm will notify the City of such planned disposition, and the City may elect to have such documents or other material delivered to the City.

APPROVAL

Please carefully review the terms and conditions of this Agreement. **If this Agreement accurately reflects the terms of this particular engagement, please obtain approval by the City Council, and execute, date and return to me the enclosed copy of this Agreement. Please retain the original for your file.**

If you have questions regarding any aspect of the above or our representation, please do not hesitate to contact me. As always, we appreciate the opportunity to represent the City of Ottumwa and we look forward to working with you.

Sincerely,

AHLERS & COONEY, P.C.

By *Kristine Stone*

Kristine Stone

Accepted and approved on behalf of the City of Ottumwa*

By: *Richard W. Johnson*
Title: Mayor

Dated: *January 2, 2024*

*Authorized by Resolution \ Motion 5-2024 approved by the City Council on January 2, 2024.

12-29-23 915A

Item No. I.-4.

CITY OF OTTUMWA Staff Summary

12-29-23

**** ACTION ITEM ****

Council Meeting of: Jan 2, 2024

Planning & Development
Department

Zach Simonson
Prepared By
Zach Simonson
Department Head



City Administrator Approval

AGENDA TITLE: RESOLUTION NO. 6-2024: A resolution removing a special assessment applied to 121 S Iowa on Resolution No. 41-2023

 Public hearing required if this box is checked.

RECOMMENDATION: Pass and adopt Resolution No. 6-2024

DISCUSSION: In March 2023 Whatsoever You Do acquired this property near their shelter. The property had accumulated mowing assessments totaling \$1,359 under the previous owner. Whatsoever You Do disputed the assessed fees claiming that they have maintained the property since 2020. Staff does not have direct documentation to substantiate the 2020 and 2021 mowing charges. Those assessments were removed last year.

Source of Funds:

Budgeted Item: Budget Amendment Needed:

A final assessment was still applied for 2022 mowing fees in the amount of \$250 plus \$5 of administrative fee. This would remove the final assessment. Removing the assessment also helps the shelter reserve funds for its nonprofit mission.

RESOLUTION NO. 6-2024

A RESOLUTION REMOVING A SPECIAL ASSESSMENT APPLIED TO 121 S IOWA ON RESOLUTION NO. 41-2023

WHEREAS, Resolution No. 41-2023, Tract #28 included an assessment for delinquent mowing fees for 121 S Iowa in the amount of \$250.00 plus \$5.00 in administrative costs; and

NOW, THEREFORE, BE IT RESOLVED BY THE CITY COUNCIL OF THE CITY OF OTTUMWA, IOWA:

The special assessments for 121 S Iowa in the amount of \$255.00 including administration costs be removed from Resolution No. 41-2023.

Approved, passed and adopted this 2nd day of January 2024.

CITY OF OTTUMWA, IOWA

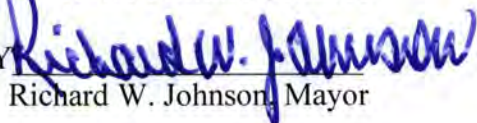
BY 
Richard W. Johnson, Mayor

ATTEST:

Chris Reinhard, City Clerk





[CITY OF]
OTTUMWA

January 3, 2024

Wapello County Treasurer
Wapello County Courthouse
101 W. Fourth
Ottumwa, IA 52501

RE: Res. No. 6-2024 – Removing special assessments applied to 121 Iowa on
Resolution No. 41-2023.

The assessments applied to:

RES NO.	TRACT NO.	ADDRESS	PROPERTY OWNER	LEGAL	AMOUNT	INTEREST	ADMIN	TOTAL
41-2023	28	121 S IOWA	JOYCE A JOHNSON	JANNEY ADD LOT 17 BLK 4	\$250	\$0	\$5	\$255

Please remove the special assessments applied to this property through Resolution No. 41-2023.

Please let me know should you require anything additional to complete this request.

Thank-you!

Sincerely,

Christina Reinhard
City Clerk
cc: Zach Simonson, Director of Community Development

WAPELLO COUNTY TREASURER
LAURIE L. FOUNTAIN
101 W Fourth St
Ottumwa, IA 52501
Phone: 641-683-0040

WhatSoEver You Do, Inc
517 Burrhus
Ottumwa , IA 52501

Assessment Notice for OTTUMWA WEED RES. 41-23

Parcel Number: 007410830098000
Deed: WhatSoEver You Do, Inc
Contract:
Property Address: 121 S IOWA OTTUMWA IA
Legal: JANNEY ADD LOT 17 BLK 4 (121 S IOWA AVE)

Special/Drainage Assessment

District	Project	Due Date	Bill Number	Amount	Interest	Admin Fee	Total
OTTUMWA CITY/ OTTUMWA SCH	OTTUMWA WEED RES. 41-23	10/02/2023	00032	\$250.00	\$0.00	\$5	\$255

The amount due above does not include any delinquent interest, which will be included in the total amount due.

received
12-29-23 915A

Item No. I.-5.

CITY OF OTTUMWA

Staff Summary

**** ACTION ITEM ****

Council Meeting of: Jan 2, 2024

Planning & Development
Department

Zach Simonson
Prepared By
Zach Simonson
Department Head



City Administrator Approval

AGENDA TITLE: Resolution No. 7-2024: A resolution authorizing a release and satisfaction for judgments against the property located at 130 S Iowa Ave

Public hearing required if this box is checked.

RECOMMENDATION: Pass and adopt Resolution No. 7-2024

DISCUSSION: The City acquired the property at 130 S Iowa in 2015 and subsequently sold it to Cabanas III, LLC. The new owner has completed a rehabilitation and the property is suitable for habitation. The owner is seeking to sell the property and during title review, has found several judgments against the property accumulated by previous owners.

Source of Funds:

Budgeted Item: Budget Amendment Needed:

Cabanas has proposed to pay the City a lump sum of \$250 for release and satisfaction of the judgments. Many of these judgments are very old and the current owner has put in significant effort to improve the value. Total property taxes on the property have increased for \$196 per year when the property was purchased to \$1,842 today. The judgments total at least \$4,000.

RESOLUTION NO. 7-2024

A RESOLUTION AUTHORIZING A RELEASE AND SATISFACTION FOR JUDGMENTS AGAINST THE PROPERTY LOCATED AT 130 S IOWA

WHEREAS, the previous owners of the property located 130 S Iowa received citations for nuisance violations in the following cases;

CICI004807	CICI004855	CICI004897	CICI004932
CICI004811	CICI004860	CICI004898	CICI004938
CICI004836	CICI004862	CICI004899	CICI004971
CICI004843	CICI004882	CICI004909	CICI005023
CICI004845	CICI004886	CICI004918	CWCICI000001
CICI004851	CICI004894	CICI004928	CICI005351

WHEREAS, the City of Ottumwa acquired the property on December 17, 2015 and subsequently sold the property to Cabanas III, LLC; and

WHEREAS, Cabanas III, LLC completed a rehabilitation of the home and has returned it to a condition suitable for habitation; and

WHEREAS, Cabanas III, LLC will pay the City of Ottumwa a sum of \$250.00 for release and satisfaction of the judgments in the above cases;

NOW, THEREFORE, BE IT RESOLVED BY THE CITY COUNCIL OF THE CITY OF OTTUMWA, IOWA:

The judgments in the above cases be released and satisfied and that the Mayor is authorized to sign the release and satisfaction.

Approved, passed and adopted this 2nd day of January 2024.

CITY OF OTTUMWA, IOWA

BY

Richard W. Johnson, Mayor

ATTEST:

Chris Reinhard, City Clerk

Pulled - No Legislative Action

received
12-29-23 9/15A

Item No. I.-6.

CITY OF OTTUMWA
Staff Summary

**** ACTION ITEM ****

Council Meeting of: Jan 2, 2024

Zach Simonson

Prepared By

Zach Simonson

Department Head

Department

City Administrator Approval

AGENDA TITLE: Resolution No. 8-2024: A resolution approving and authorizing execution of an agreement for private development and off-site improvements by and between the City of Ottumwa and Christner Properties, LLC

Public hearing required if this box is checked.

RECOMMENDATION: Pass and adopt Resolution No. 8-2024

DISCUSSION:

Christner properties has proposed a four-unit, single family subdivision on East Court and has begun some construction on the site. The site requires an extension of the sewer in order to serve the new development. The estimated cost of the sewer work is \$81,000. Christner has requested assistance with this unanticipated cost. The proposed agreement would provide 75% of the total cost up to \$52,000. The development would

Source of Funds: Sewer Fund

Budgeted Item:

Budget Amendment Needed: Yes

provide 4 new market-rate, single-family homes. Christner has reported to the City that the incentive is necessary to complete the development.

ITEM TO INCLUDE ON AGENDA

CITY OF OTTUMWA, IOWA

January 2, 2024

5:30 P.M.

- Resolution approving and authorizing execution of an Agreement for Private Development and Off-Site Improvements by and between the City of Ottumwa and Christner Properties, L.L.C.

IMPORTANT INFORMATION

1. The above agenda items should be included, along with any other agenda items, in the meeting agenda. The agenda should be posted on a bulletin board or other prominent place easily accessible to the public and clearly designated for that purpose at the principal office of the body holding the meeting. If no such office exists, the notice must be posted at the building in which the meeting is to be held.
2. If you do not now have a bulletin board designated as above mentioned, designate one and establish a uniform policy of posting your notices of meeting and tentative agenda.
3. Notice and tentative agenda must be posted at least 24 hours prior to the commencement of the meeting.

NOTICE MUST BE GIVEN PURSUANT TO CHAPTER 21,
CODE OF IOWA, AND THE LOCAL RULES OF THE CITY.

January 2, 2024

The City Council of the City of Ottumwa in the State of Iowa, met in _____ session, in the Council Chambers, City Hall, 105 East Third Street, Ottumwa, Iowa, at 5:30 P.M., on the above date. There were present Mayor _____, in the chair, and the following named Council Members:

Absent: _____

Vacant: _____

* * * * *

Council Member _____ introduced and delivered to the Clerk the Resolution hereinafter set out entitled "RESOLUTION APPROVING AND AUTHORIZING EXECUTION OF AN AGREEMENT FOR PRIVATE DEVELOPMENT AND OFF-SITE IMPROVEMENTS BY AND BETWEEN THE CITY OF OTTUMWA AND CHRISTNER PROPERTIES, L.L.C.", and moved:

- that the Resolution be adopted.
- to defer action on the Resolution and the proposal to the meeting to be held at _____ .M. on the _____ day of _____, 2024, at this place.

Council Member _____ seconded the motion. The roll was called, and the vote was:

AYES: _____

NAYS: _____

Whereupon, the Mayor declared the measure duly adopted.

RESOLUTION NO. 8-2024

RESOLUTION APPROVING AND AUTHORIZING
EXECUTION OF AN AGREEMENT FOR PRIVATE
DEVELOPMENT AND OFF-SITE IMPROVEMENTS BY AND
BETWEEN THE CITY OF OTTUMWA AND CHRISTNER
PROPERTIES, L.L.C.

WHEREAS, the City has received a proposal from Christner Properties, L.L.C. (the "Developer"), in the form of a proposed Agreement for Private Development and Off-Site Improvements (the "Agreement") by and between the City and the Developer, pursuant to which, among other things, the Developer would agree to construct certain Minimum Improvements on certain real property located within the City (the "Development Property") and certain off-site Infrastructure Improvements to provide for the delivery of sewer services to the Minimum Improvements, all as outlined in the proposed Agreement; and

WHEREAS, the Agreement further proposes that, under the terms and following Developer's satisfaction of the conditions set forth in the Agreement, the City will make a one-time payment of an Economic Development Grant to Developer from the City's Sewer Fund, in the amount of 75% of the Developer-submitted Qualified Costs and Expenses (as defined in the Agreement), but not to exceed \$52,000; and

WHEREAS, the Council has determined that the Agreement is in the best interests of the City and the residents thereof and that the performance by the City of its obligations thereunder is a public undertaking and purpose.

NOW THEREFORE, BE IT RESOLVED, BY THE CITY COUNCIL OF THE CITY OF OTTUMWA IN THE STATE OF IOWA:

Section 1. That the performance by the City of its obligations under the Agreement, including but not limited to providing a grant to the Developer in connection with the development of the Development Property under the terms set forth in the Agreement, be and is hereby declared to be a public undertaking and purpose.

Section 2. That the form and content of the Agreement, the provisions of which are incorporated herein by reference, be and the same hereby are in all respects authorized, approved and confirmed, and the Mayor and the City Clerk be and they hereby are authorized, empowered and directed to execute, attest, seal and deliver the Agreement for and on behalf of the City in substantially the form and content now before this meeting, but with such changes, modifications, additions or deletions therein as shall be approved by such officers, and that from and after the execution and delivery of the Agreement, the Mayor and the City Clerk are hereby authorized, empowered and directed to do all such acts and things and to execute all such documents as may be necessary to carry out and comply with the provisions of the Agreement as executed.

PASSED AND APPROVED this 2nd day of January, 2024.

Mayor

ATTEST:

City Clerk

CERTIFICATE

STATE OF IOWA

)

) SS

COUNTY OF WAPELLO

)

I, the undersigned City Clerk of the City of Ottumwa, State of Iowa, do hereby certify that attached is a true and complete copy of the portion of the records of the City showing proceedings of the Council, and the same is a true and complete copy of the action taken by the Council with respect to the matter at the meeting held on the date indicated in the attachment, which proceedings remain in full force and effect, and have not been amended or rescinded in any way; that meeting and all action thereat was duly and publicly held in accordance with a notice of meeting and tentative agenda, a copy of which was timely served on each member of the Council and posted on a bulletin board or other prominent place easily accessible to the public and clearly designated for that purpose at the principal office of the Council pursuant to the local rules of the Council and the provisions of Chapter 21, Code of Iowa, upon reasonable advance notice to the public and media at least twenty-four hours prior to the commencement of the meeting as required by law and with members of the public present in attendance; I further certify that the individuals named therein were on the date thereof duly and lawfully possessed of their respective city offices as indicated therein, that no Council vacancy existed except as may be stated in the proceedings, and that no controversy or litigation is pending, prayed or threatened involving the incorporation, organization, existence or boundaries of the City or the right of the individuals named therein as officers to their respective positions.

WITNESS my hand and the seal of the Council hereto affixed this _____ day of _____, 2024.

City Clerk, City of Ottumwa, State of Iowa

(SEAL)

**AGREEMENT FOR PRIVATE DEVELOPMENT
AND OFF-SITE IMPROVEMENTS**

THIS AGREEMENT FOR PRIVATE DEVELOPMENT AND OFF-SITE IMPROVEMENTS (hereinafter the "Agreement"), is made on or as of the _____ day of _____, 2024, by and between the CITY OF OTTUMWA, IOWA, a municipality (hereinafter the "City"), and CHRISTNER PROPERTIES, L.L.C., an Iowa limited liability company (hereinafter the "Developer").

WITNESSETH:

WHEREAS, the Developer owns certain real property legally described as follows:

Lots 1, 2, 3 and 4 in Christner Second Subdivision, Ottumwa, Iowa

(which property as so described is hereinafter referred to as the "Development Property"); and

WHEREAS, the Developer is willing to cause certain Minimum Improvements to be constructed on the Development Property and certain off-site Infrastructure Improvements to be constructed to provide for the delivery of utility services to the Minimum Improvements (the "Project"); and

WHEREAS the City is willing to provide incentives for the Developer's completion of the Project in order to promote economic development within the City, in a manner consistent with the requirements of the Ottumwa Municipal Code; and

WHEREAS, the City believes that the development of the Development Property pursuant to this Agreement and the fulfillment generally of this Agreement, are in the vital and best interests of the City and in accord with the public purposes and provisions of the applicable State and local laws and requirements under which the foregoing project has been undertaken and is being assisted.

NOW, THEREFORE, in consideration of the premises and the mutual obligations of the parties hereto, each of them does hereby covenant and agree with the other as follows:

ARTICLE I. DEFINITIONS

Section 1.1. Definitions. In addition to other definitions set forth in this Agreement, all capitalized terms used and not otherwise defined herein shall have the following meanings unless a different meaning clearly appears from the context:

Agreement means this Agreement and all exhibits and appendices hereto, as the same may be from time to time modified, amended, or supplemented.

City means the City of Ottumwa, Iowa.

Commencement Date means the date of this Agreement, which shall be the date the Agreement is executed by both parties.

County means the County of Wapello, Iowa.

Developer means Christner Properties, L.L.C. and its permitted successors and assigns.

Economic Development Grant means the payment that may be made by the City to the Developer under Article VIII of this Agreement.

Event of Default means any of the events described in Section 9.1 of this Agreement.

Infrastructure Improvements mean the construction or installation of a sewer extension to be completed by Developer on the Licensed Premises to allow for the development of the Minimum Improvements.

Licensed Premises means the City-owned property to which the City grants Developer a license to accept for purposes of constructing the Infrastructure Improvements, which property is described on Exhibit A attached hereto and made a part hereof.

Minimum Improvements means the four (4) single-family housing units to be completed by Developer on the Development Property, as more particularly described in Exhibit B to this Agreement.

Project shall mean the construction of the Minimum Improvements on the Development Property and the construction of the Infrastructure Improvements, as described in this Agreement.

Qualified Costs and Expenses means the costs and expenses incurred by Developer and related to the design and construction of the Infrastructure Improvements, including, without limitation, interest during construction and for not more than six months thereafter, costs for landscaping, grading, drainage, paving, engineering, plans and specifications, labor, materials, supplies, equipment use and rental, delivery charges, overhead, mobilization and legal expenses related to those improvements, as more particularly described herein.

State means the State of Iowa.

Termination Date means the date this Agreement terminates, as established in Section 10.9 of this Agreement.

Unavoidable Delays means delays resulting from acts or occurrences outside the reasonable control of the party claiming the delay including but not limited to storms, floods, fires, explosions, or other casualty losses, unusual weather conditions, strikes, boycotts, lockouts, or other labor disputes, litigation commenced by third parties, or the acts of any federal, State, or local governmental unit (other than the City with respect to the City's obligations).

ARTICLE II. REPRESENTATIONS AND WARRANTIES

Section 2.1. Representations and Warranties of the City. The City makes the following representations and warranties:

a. The City is a municipal corporation and political subdivision organized under the provisions of the Constitution and the laws of the State and has the power to enter into this Agreement and carry out its obligations hereunder.

b. The execution and delivery of this Agreement, the consummation of the transactions contemplated hereby, and the fulfillment of or compliance with the terms and conditions of this Agreement are not prevented by, limited by, in conflict with, or result in a breach of, the terms, conditions, or provisions of any contractual restriction, evidence of indebtedness, agreement, or instrument of whatever nature to which the City is now a party or by which it is bound, nor do they constitute a default under any of the foregoing.

c. All covenants, stipulations, promises, agreements, and obligations of the City contained herein shall be deemed to be the covenants, stipulations, promises, agreements, and obligations of the City only, and not of any governing body member, officer, agent, servant, or employee of the City in the individual capacity thereof.

Section 2.2. Representations and Warranties of Developer. The Developer makes the following representations and warranties:

a. The Developer is an Iowa limited liability company duly organized and validly existing under the laws of the State of Iowa, and has all requisite power and authority to own and operate its properties, to carry on its business as now conducted and as presently proposed to be conducted, and to enter into and perform its obligations under this Agreement.

b. This Agreement has been duly and validly authorized, executed, and delivered by the Developer and, assuming due authorization, execution, and delivery by the City, is in full force and effect and is a valid and legally binding instrument of the Developer enforceable in accordance with its terms, except as the same may be limited by bankruptcy, insolvency, reorganization, or other laws relating to or affecting creditors' rights generally.

c. The execution and delivery of this Agreement, the consummation of the transactions contemplated hereby, and the fulfillment of or compliance with the terms and conditions of this Agreement are not prevented by, limited by, in conflict with, or result in a violation or breach of, the terms, conditions, or provisions of the governing documents of the Developer or of any contractual restriction, evidence of indebtedness, agreement, or instrument of whatever nature to which the Developer is now a party or by which it or its property is bound, nor do they constitute a default under any of the foregoing.

d. There are no actions, suits, or proceedings pending or threatened against or affecting the Developer in any court or before any arbitrator or before or by any governmental body in which there is a reasonable possibility of an adverse decision which could materially adversely affect the business (present or prospective), financial position, or results of operations

of the Developer or which in any manner raises any questions affecting the validity of the Agreement or the Developer's ability to perform its obligations under this Agreement.

e. The Developer shall cause the Minimum Improvements to be constructed on the Development Property in accordance with the terms of this Agreement and all local, State, and federal laws and regulations.

f. The Developer will use its best efforts to obtain, or cause to be obtained, in a timely manner, all required permits, licenses, and approvals, and will meet, in a timely manner, all requirements of all applicable local, State, and federal laws and regulations which must be obtained or met before the Minimum Improvements or Infrastructure Improvements may be lawfully constructed.

g. The Developer has not received any notice from any local, State, or federal official that the activities of the Developer with respect to the Development Property may or will be in violation of any environmental law or regulation (other than those notices, if any, of which the City has previously been notified in writing). The Developer is not currently aware of any State or federal claim filed or planned to be filed by any party relating to any violation of any local, State, or federal environmental law, regulation, or review procedure applicable to the Development Property, and the Developer is not currently aware of any violation of any local, State, or federal environmental law, regulation, or review procedure which would give any person a valid claim under any State or federal environmental statute with respect thereto.

h. The Developer has firm commitments for construction or acquisition and permanent financing for the Project in an amount sufficient, together with equity commitments, to successfully complete the Minimum Improvements in accordance with the Construction Plans contemplated in this Agreement.

i. The Developer will cooperate fully with the City in resolution of any traffic, parking, trash removal, or public safety problems which may arise in connection with the construction and operation of the Minimum Improvements.

j. The Developer expects that, barring Unavoidable Delays, construction of the Minimum Improvements shall be complete on or before December 31, 2026.

k. The Developer would not undertake its obligations under this Agreement without the incentives offered to the Developer pursuant to this Agreement.

ARTICLE III. MINIMUM IMPROVEMENTS

Section 3.1. Construction of Minimum Improvements. The Developer agrees that it will cause the Minimum Improvements to be constructed on the Development Property in conformance with all applicable federal, State, and local laws, ordinances, and regulations, including any City permit and/or building requirements. All work with respect to the Minimum Improvements shall be in conformity with any plans approved and/or permits issued by the building official(s) of the City, which approvals and permits shall be made according to standard City processes for such

plans and permits. The Developer agrees that the scope and scale of the Minimum Improvements as constructed shall not be significantly less than the scope and scale as detailed and outlined in this Agreement.

The Developer agrees that it shall permit designated representatives of the City, upon reasonable notice to the Developer (which does not have to be written), to enter upon the Development Property during the construction of the Minimum Improvements to inspect such construction and the progress thereof.

Section 3.2. Commencement and Completion of Construction. Subject to Unavoidable Delays, the Developer shall cause construction of the Minimum Improvements to be undertaken and completed by December 31, 2026, or such other date as the parties shall mutually agree upon in writing. Time lost as a result of Unavoidable Delays shall be added to extend this date by a number of days equal to the number of days lost as a result of Unavoidable Delays.

Notwithstanding the forgoing, the City shall not issue a certificate of occupancy for the Minimum Improvements or other buildings constructed on the Development Property unless and until the Infrastructure Improvements are fully complete and accepted by and dedicated to the City, consistent with the provisions of Article IV.

Section 3.3. Insurance Requirements.

a. Developer shall provide and maintain or cause to be maintained at all times during the process of constructing the Minimum Improvements (and, from time to time at the request of the City, furnish the City with proof of coverage or payment of premiums on):

i. Builder's risk insurance, written on the so-called "Builder's Risk-Completed Value Basis," in an amount equal to the full replacement cost of the Infrastructure Improvements, and with coverage available in non-reporting form on the so-called "all risk" form of policy.

ii. Comprehensive general liability insurance (including operations, contingent liability, operations of subcontractors, completed operations, and contractual liability insurance) with limits against bodily injury and property damage of at least \$1,000,000 for each occurrence. The City shall be named as an additional insured for the City's liability or loss arising out of or in any way associated with the project and arising out of any act, error, or omission of Developer, or either entity's directors, officers, shareholders, contractors, and subcontractors or anyone else for whose acts the City may be held responsible (with coverage to the City at least as broad as that which is provided to Developer and not lessened or avoided by endorsement). The policy shall contain a "severability of interests" clause and provide primary insurance over any other insurance maintained by the City.

iii. Workers' compensation insurance with at least statutory coverage.

b. Upon completion of construction of the Minimum Improvements and at all times prior to the Termination Date, Developer shall (i) maintain or cause to be maintained, at its cost and expense (and from time to time at the request of the City shall furnish proof of coverage or the payment of premiums on), insurance on the Minimum Improvements and Development Property as is statutorily required and any additional insurance customarily carried by like enterprises engaged in like activities of comparable size and liability exposure and (ii) complete the repair, reconstruction, and restoration of the Minimum Improvements, whether or not the Net Proceeds of insurance received by Developer for such purposes are sufficient; provided, however, that any portion of the Minimum Improvements or Development Property no longer owned by Developer shall be excepted from the requirements of this Section 3.3(b).

c. All insurance required by this Section 3.3 to be provided prior to the Termination Date shall be taken out and maintained in responsible insurance companies selected by Developer, which are authorized under the laws of the State to assume the risks covered thereby.

Section 3.4. Real Property Taxes; Eligibility for Urban Revitalization.

a. Developer, or its successors, shall pay or cause to be paid, when due, all real property taxes and assessments payable with respect to all and any parts of the Minimum Improvements and Development Property.

b. Developer and its successors agree that, prior to the Termination Date, they will not seek administrative review or judicial review of the applicability or constitutionality of any tax statute relating to the taxation of real property contained on the Development Property determined by any tax official to be applicable to the Development Property or Minimum Improvements, or raise the inapplicability or constitutionality of any such tax statute as a defense in any proceedings, including delinquent tax proceedings.

c. Notwithstanding the foregoing subsections of Section 3.4, the City hereby agrees that Developer may apply for tax abatement for the completed Minimum Improvements under the terms and conditions of the City's Urban Revitalization Plan, subject to Developer's timely application and eligibility for such abatement thereunder.

ARTICLE IV. INFRASTRUCTURE IMPROVEMENTS

Section 4.1. License for Access and Construction. Beginning upon the Commencement Date, the City grants to the Developer and its employees, agents, and contractors a license to enter upon the City's property that is described on Exhibit A (the "Licensed Premises") for the purpose of constructing the Infrastructure Improvements.

Section 4.2. Construction of Infrastructure Improvements. The Developer shall cause the Infrastructure Improvements to be constructed in accordance with the design standards required by City Code. The Infrastructure Improvements shall be constructed at the Developer's sole expense, at an expected cost of approximately \$70,000.

In performing work or other activities upon the Licensed Premises, Developer and its employees, agents, and contractors shall perform the work in a manner so as to prevent damage to existing improvements identified by the City, shall observe and comply with all terms and requirements contained in any orders issued by the City, and shall comply with applicable federal, State, and local laws, regulations, ordinances, policies, and procedures.

For all work to be performed within the Licensed Premises by contractors of the Developer, Developer shall obtain the City's prior written approval of all plans and specifications for such work. The Developer shall require its contractors to perform work within the Licensed Premises to the reasonable satisfaction of the City, and in compliance with its previously approved plans and specifications. The City shall have and possess final rights of approval, acting reasonably, of all plans and specifications within the Licensed Premises. The City Engineer shall be permitted to inspect all work performed on the Licensed Premises. Notwithstanding the ability of the City to inspect the work, the Developer shall have full responsibility to ensure that the work is completed in accordance with the plans and specifications provided to the City.

Section 4.3. Completion of Infrastructure Improvements; Guarantee.

a. Upon notice from the Developer of completion of the Infrastructure Improvements, the City Engineer, or their qualified designee, shall inspect the Infrastructure Improvements and determine whether they have been completed in accordance with the applicable standards for such improvements. If the City finds that the Infrastructure Improvements have been duly completed in compliance with this Agreement and all federal, State, and local laws, regulations, ordinances, policies, and procedures, and the City is in receipt of copies of the maintenance bonds required by Section 4.4, then the Developer shall dedicate to the City and the City shall accept dedication of the Infrastructure Improvements.

b. By signing this Agreement, Developer hereby guarantees to the City performance by the Developer of all the terms and provisions of this Agreement pertaining to Developer's obligations with respect to the construction of the Infrastructure Improvements. Without limiting the generality of the foregoing, the Developer guarantees that: (1) the Infrastructure Improvements shall be constructed and completed free and clear of any mechanic's liens, materialman's liens, and equitable liens; and (2) the Developer shall pay all costs of constructing the Infrastructure Improvements when due.

Section 4.4. Bonding Requirements. Developer has the ability to and shall cause Christner Contracting, Inc. to maintain its permit bond until the Termination Date. The Developer shall also comply with all City requirements for the construction of the Infrastructure Improvements.

Section 4.5. No Special Legal Entitlements to Infrastructure Improvements. Developer recognizes and agrees, that upon dedication to the City and the City's acceptance thereof, the Infrastructure Improvements shall be owned by the City and that nothing in this Agreement grants Developer any special legal entitlements or other rights not held by members of the general public with respect to ownership, sufficiency for any particular purpose, or use of the Infrastructure Improvements.

ARTICLE V. COVENANTS OF THE DEVELOPER

Section 5.1. Maintenance of Properties. The Developer will maintain, preserve, and keep its properties in the City (whether owned in fee or a leasehold interest), including but not limited to the Development Property, in good repair and working order, ordinary wear and tear excepted, and from time to time will make all necessary repairs, replacements, renewals, and additions; provided, however, that any portion of the Minimum Improvements or Development Property no longer owned by Developer shall be excepted from the requirements of this Section 5.1.

Section 5.2. Maintenance of Records. The Developer will keep at all times proper books of record and account in which full, true, and correct entries will be made of all dealings and transactions of or in relation to the business and affairs of the Developer relating to this Project in accordance with generally accepted accounting principles, consistently applied throughout the period involved, and the Developer will provide reasonable protection against loss or damage to such books of record and account.

Section 5.3. Compliance with Laws. The Developer will comply with all State, federal, and local laws, rules, and regulations relating to the Project.

Section 5.4. Non-Discrimination. In the course of undertaking the Project, the Developer shall not discriminate against any applicant, employee, homebuyer, or tenant because of age, color, creed, national origin, race, religion, marital status, sex, physical disability, or familial status. Developer shall ensure that applicants, employees, homebuyers, and tenants are considered and are treated without regard to their age, color, creed, national origin, race, religion, marital status, sex, physical disability, or familial status.

Section 5.5. Available Information. Upon request, Developer shall promptly provide the City with copies of information requested by City that are related to this Agreement so that City can determine compliance with the Agreement.

ARTICLE VI. ASSIGNMENT AND TRANSFER

Section 6.1. Transfer of Substantially All Assets; Assignment. As security for the obligations of the Developer under this Agreement, the Developer represents and agrees that, prior to the Termination Date, the Developer will not dispose of all or substantially all of its assets or transfer, convey, or assign its interest in this Agreement to any other party unless (i) the transferee partnership, corporation or individual assumes in writing all of the obligations of the Developer under this Agreement and (ii) the City consents thereto in writing in advance thereof, which consent shall not be unreasonably withheld.

Section 6.2. Prohibition Against Use as Non-Taxable or Centrally-Assessed Property. During the term of this Agreement, the Developer agrees that no portion of the Development Property or Minimum Improvements shall be transferred or sold to a non-profit entity or used for a purpose that would exempt said portion of the Development Property from property tax liability. Notwithstanding the prior sentence, Developer may convey portions of the Development Property to the City to be used by the City for public infrastructure, or other public purposes. During the

term of this Agreement, Developer agrees not to allow any portion of the Development Property or Minimum Improvements to be used as centrally-assessed property (including but not limited to, Iowa Code § 428.24 to 428.29 (Public Utility Plants and Related Personal Property); Chapter 433 (Telegraph and Telephone Company Property); Chapter 434 (Railway Property); Chapter 437 (Electric Transmission Lines); Chapter 437A (Property Used in the Production, Generation, Transmission or Delivery of Electricity or Natural Gas); and Chapter 438 (Pipeline Property)).

ARTICLE VII. INDEMNIFICATION

Section 7.1. Indemnification.

a. To the fullest extent permitted by law, the Developer agrees to defend, pay on behalf of, indemnify, and hold harmless the City against any and all claims, demands, suits, damages or losses, together with any and all outlay and expense connected therewith including, but not limited to, attorneys' fees and court costs that may be asserted or claimed against, recovered from or suffered by the City by reason of any injury or loss including, but not limited to, personal injury, bodily injury including death, property damage including loss of use thereof, and economic damages that arise out of or are in any way connected or associated with the Development Property, the Developer's construction of the Minimum Improvements, or the Developer's construction of the Infrastructure Improvements, including that of its officers, agents, employees, contractors, subcontractors and others under the control of Developer, except to the extent caused by or resulting from the negligent act or omission of the City or the City's employees, consultants, agents or others for whom the City is responsible.

b. The Developer's obligation to indemnify the City contained in this Agreement is not limited by the amount or type of damages, compensation or benefits payable under any workers' compensation acts, disability benefit acts, or other employee benefits acts.

c. The City shall not be liable or in any way responsible for any injury, damage, liability, claim, loss or expense incurred by the Developer rising out of or in any way connected or associated with the Development Property, the Developer's construction of the Minimum Improvements, or the Developer's construction of the Infrastructure Improvements, including that of its officers, agents, employees, subcontractors and others under the control of Developer, except to the extent caused by or resulting from the negligent act or omission of the City or the City's employees, consultants, agents or others for whom the City is responsible.

d. The Developer expressly assumes responsibility for any and all damage caused to City property arising out of or in any way connected or associated with Developer's construction of the Infrastructure Improvements, including that of its officers, agents, employees, contractors, subcontractors and others under the control of Developer.

e. The provisions of this Section 7.1 shall survive the expiration or termination of this Agreement.

ARTICLE VIII. PROJECT INCENTIVES

Section 8.1. Economic Development Grant.

a. For and in consideration of the Developer's completion of the Project, the City agrees to provide Developer a grant ("Economic Development Grant") within thirty (30) days of the satisfaction of the following conditions precedent:

i. The Infrastructure Improvements have been completed and the City has accepted dedication of the Infrastructure Improvements, consistent with the terms of Section 4.2; and

ii. The Developer has submitted a certification to the City, in substantially the form of Exhibit D attached hereto, certifying the amount of all Qualified Costs and Expenses of the Infrastructure Improvements dedicated to and accepted by the City, and further certifying that the costs of constructing the Infrastructure Improvements did not exceed \$81,000.

b. The amount of the Economic Development Grant shall be equal to 75% of the Developer-submitted Qualified Costs and Expenses that are reviewed and approved by the City Engineer as reasonable and related to the Infrastructure Improvements, but in no case shall exceed \$52,000.

c. The Economic Development Grant shall be payable solely and only from the City's Sewer Fund. Notwithstanding the provisions of Section 8.1 hereof, the City shall have no obligation to make Economic Development Grant to Developer if at any time during the term hereof the City fails to appropriate funds for payment, or receives an opinion from its legal counsel to the effect that the use of Sewer Fund monies to make the Economic Development Grant to Developer, as contemplated under said Section 8.1, is not authorized or otherwise an appropriate activity permitted to be undertaken by the City under applicable provisions of the Iowa Code, as then constituted or under controlling decision of any Iowa Court having jurisdiction over the subject matter hereof. Upon receipt of any such legal opinion or non-appropriation, the City shall promptly forward notice of the same to Developer, and the City may terminate this Agreement, without penalty or other liability to the City, by written notice to Developer.

d. In the event that an Event of Default has occurred and has not been cured or cannot reasonably be cured before the payment of the Economic Development Grant, then the City shall have no obligation to make the Economic Development Grant payment, in addition to having the remedies set forth in Section 9.2.

Section 8.2. Sewer Connection Fees. For and in consideration of the Developer's completion of the Project, the City agrees to waive the sewer connection fees for the Minimum Improvements constructed on the Development Property, provided the Minimum Improvements are duly constructed in accordance with the terms and conditions of this Agreement and no Event of Default has occurred and is continuing.

Section 8.3. Build Ottumwa Incentive. The City agrees that it shall not consider the Developer or the Minimum Improvements ineligible for a Build Ottumwa incentive on the basis of the incentives provided pursuant to this Agreement.

ARTICLE IX. DEFAULT AND REMEDIES

Section 9.1. Events of Default. The following shall be “Events of Default” under this Agreement and the term “Event of Default” shall mean, whenever it is used in this Agreement, any one or more of the following events:

a. Failure by the Developer to cause the construction of the Minimum Improvements or Infrastructure Improvements to be commenced and completed pursuant to the terms, conditions, and limitations of this Agreement; or

b. Failure by the Developer to substantially observe or perform any covenant, condition, obligation, or agreement on its part to be observed or performed under this Agreement; or

c. Any representation or warranty made by the Developer in this Agreement, or made by the Developer in any written statement or certification furnished by the Developer pursuant to this Agreement, shall prove to have been incorrect, incomplete or misleading in any material respect on or as of the date of the issuance or making thereof.

Section 9.2. Remedies on Default. Whenever any Event of Default referred to in Section 9.1 of this Agreement occurs and is continuing, the City may take any one or more of the following actions after the giving of thirty (30) days’ written notice by the City to the Developer of the Event of Default, but only if the Event of Default has not been cured within said thirty (30) days, or if the Event of Default cannot reasonably be cured within thirty (30) days and the Developer does not provide assurances reasonably satisfactory to the City that the Event of Default will be cured as soon as reasonably possible:

a. The City may suspend its performance under this Agreement until it receives assurances from the Developer, deemed adequate by the City, that the Developer will cure its default and continue its performance under this Agreement;

b. The City may terminate this Agreement;

c. The City shall have no obligation thereafter to provide the Economic Development Grant; and

d. The City may take any action, including legal, equitable, or administrative action, which may appear necessary or desirable to enforce performance and observance of any obligation, agreement, or covenant of the Developer, as the case may be, under this Agreement.

Section 9.3. No Remedy Exclusive. No remedy herein conferred upon or reserved to the City is intended to be exclusive of any other available remedy or remedies, but each and every remedy shall be cumulative and shall be in addition to every other remedy given under this Agreement or now or hereafter existing at law or in equity or by statute. No delay or omission to exercise any right or power accruing upon any default shall impair any such right or power or shall

be construed to be a waiver thereof, but any such right and power may be exercised from time to time and as often as may be deemed expedient.

Section 9.4. No Implied Waiver. In the event any agreement contained in this Agreement should be breached by any party and thereafter waived by any other party, such waiver shall be limited to the particular breach so waived and shall not be deemed to waive any other concurrent, previous or subsequent breach hereunder.

Section 9.5. Agreement to Pay Attorneys' Fees and Expenses. Whenever any Event of Default occurs and the City shall employ attorneys or incur other expenses for the collection of payments due or to become due or for the enforcement or performance or observance of any obligation or agreement on the part of the Developer herein contained, the Developer agrees that it shall, on demand therefor, pay to the City the reasonable fees of such attorneys and such other expenses as may be reasonably and appropriately incurred by the City in connection therewith.

ARTICLE X. MISCELLANEOUS

Section 10.1. Conflict of Interest. The Developer represents and warrants that, to its best knowledge and belief after due inquiry, no officer or employee of the City, or its designees or agents, nor any consultant or member of the governing body of the City, and no other public official of the City who exercises or has exercised any functions or responsibilities with respect to the Project during his or her tenure, or who is in a position to participate in a decision-making process or gain insider information with regard to the Project, has had or shall have any interest, direct or indirect, in any contract or subcontract, or the proceeds thereof, for work or services to be performed in connection with the Project, or in any activity, or benefit therefrom, which is part of the Project at any time during or after such person's tenure.

Section 10.2. Notices and Demands. A notice, demand or other communication under this Agreement by any party to the other shall be sufficiently given or delivered if it is dispatched by registered or certified mail, postage prepaid, return receipt requested, or delivered personally, and

- a. In the case of the Developer, is addressed or delivered personally to Christner Properties, L.L.C. at 17587 US Hwy 34, Ottumwa, IA 52501; Attn: Anthony Christner; and
- b. In the case of the City, is addressed to or delivered personally to the City of Ottumwa at 105 E. Third Street, Ottumwa, IA 52501; Attn: City Clerk;

or to such other designated individual or officer or to such other address as any party shall have furnished to the other in writing in accordance herewith.

Section 10.3. Memorandum of Agreement. The parties agree to execute and record a Memorandum of Agreement for Private Development, in substantially the form attached as Exhibit C, to serve as notice to the public of the existence and provisions of this Agreement, and the rights and interests held by the City by virtue hereof. The City shall pay for the costs of recording.

Section 10.4. Titles of Articles and Sections. Any titles of the several parts, Articles, and Sections of this Agreement are inserted for convenience of reference only and shall be disregarded in construing or interpreting any of its provisions.

Section 10.5. Counterparts. This Agreement may be executed in any number of counterparts, each of which shall constitute one and the same instrument.

Section 10.6. Governing Law. This Agreement shall be governed and construed in accordance with the laws of the State of Iowa.

Section 10.7. Entire Agreement. This Agreement and the exhibits hereto reflect the entire agreement between the parties regarding the subject matter hereof, and supersedes and replaces all prior agreements, negotiations or discussions, whether oral or written. This Agreement may not be amended except by a subsequent writing signed by all parties hereto.

Section 10.8. Successors and Assigns. This Agreement is intended to and shall inure to the benefit of and be binding upon the parties hereto and their respective successors and assigns.

Section 10.9. Termination Date. This Agreement shall terminate and be of no further force or effect on and after March 1, 2027, unless the Agreement is terminated earlier by the other terms of this Agreement.

Section 10.10. No Third-Party Beneficiaries. No rights or privileges of either party hereto shall inure to the benefit of any landowner, homebuyer, contractor, subcontractor, material supplier, or any other person or entity, and no such contractor, landowner, subcontractor, material supplier, or any other person or entity shall be deemed to be a third-party beneficiary of any of the provisions contained in this Agreement.

IN WITNESS WHEREOF, the City has caused this Agreement to be duly executed in its name and behalf by its Mayor and its seal to be hereunto duly affixed and attested by its City Clerk, the Developer has caused this Agreement to be duly executed in its name and behalf all on or as of the day first above written.

[Signature pages follow]

(SEAL)

CITY OF OTTUMWA, IOWA

By: _____
Richard Johnson, Mayor

ATTEST:

By: _____
Christina Reinhard, City Clerk

STATE OF IOWA)
) SS
COUNTY OF WAPELLO)

On this _____ day of _____, 2024, before me a Notary Public in and for said State, personally appeared Richard Johnson and Christina Reinhard, to me personally known, who being duly sworn, did say that they are the Mayor and City Clerk, respectively, of the City of Ottumwa, Iowa, a Municipality created and existing under the laws of the State of Iowa, and that the seal affixed to the foregoing instrument is the seal of said Municipality, and that said instrument was signed and sealed on behalf of said Municipality by authority and resolution of its City Council, and said Mayor and City Clerk acknowledged said instrument to be the free act and deed of said Municipality by it voluntarily executed.

Notary Public in and for the State of Iowa

[Signature page to Agreement– City of Ottumwa, Iowa]

EXHIBIT A
LICENSED PREMISES

The Licensed Premises is the City-owned real estate described as follows:

The full road right-of-way of East Court Street from Oak Street to the 1300 block; of Oak Street from Lincoln Avenue to East Court Street; and of North Fellows Avenue from Lincoln Avenue to East Court Street.

EXHIBIT B
MINIMUM IMPROVEMENTS

The Minimum Improvements include the construction of four (4) single-family homes and related site improvements on the Development Property, to be constructed consistent with approved plats and plans.

EXHIBIT C
MEMORANDUM OF AGREEMENT FOR PRIVATE DEVELOPMENT

WHEREAS, the City of Ottumwa, Iowa (the “City”) and Christner Properties, L.L.C., an Iowa limited liability company (the “Developer”), did on or about _____, 2024, make, execute, and deliver an Agreement for Private Development (the “Agreement”), wherein and whereby the Developer agreed, in accordance with the terms of the Agreement, to develop and maintain certain real property located within the City legally described as follows:

Lots 1, 2, 3 and 4 in Christner Second Subdivision, Ottumwa, Iowa

WHEREAS, the term of the Agreement commenced on the date first set forth above and will terminate on March 1, 2027, if not terminated sooner according to the terms and conditions set forth in the Agreement; and

WHEREAS, the City and the Developer desire to record a Memorandum of the Agreement referring to the above-described real property and their respective interests therein.

NOW, THEREFORE, IT IS AGREED AS FOLLOWS:

1. That the recording of this Memorandum of Agreement for Private Development shall serve as notice to the public that the Agreement contains provisions restricting development and use of the above-described real property and the improvements located and operated thereon.

2. That all of the provisions of the Agreement and any subsequent amendments thereto, if any, even though not set forth herein, are by the filing of this Memorandum of Agreement for Private Development made a part hereof by reference, and that anyone making any claim against any of the above-described real property in any manner whatsoever shall be fully advised as to all of the terms and conditions of the Agreement, and any amendments thereto, as if the same were fully set forth herein.

3. That a copy of the Agreement and any subsequent amendments thereto, if any, shall be maintained on file for public inspection during ordinary business hours in the office of the City Clerk, City Hall, Ottumwa, Iowa.

IN WITNESS WHEREOF, the City and the Developer have executed this Memorandum of Agreement for Private Development as of the ____ day of _____, 2024.

[Rest of page intentionally left blank; Signature pages to follow]

(SEAL)

CITY OF OTTUMWA, IOWA

By: _____
Richard Johnson, Mayor

ATTEST:

By: _____
Christina Reinhard, City Clerk

STATE OF IOWA)
) SS
COUNTY OF WAPELLO)

On this _____ day of _____, 2024, before me a Notary Public in and for said State, personally appeared Richard Johnson and Christina Reinhard, to me personally known, who being duly sworn, did say that they are the Mayor and City Clerk, respectively, of the City of Ottumwa, Iowa, a Municipality created and existing under the laws of the State of Iowa, and that the seal affixed to the foregoing instrument is the seal of said Municipality, and that said instrument was signed and sealed on behalf of said Municipality by authority and resolution of its City Council, and said Mayor and City Clerk acknowledged said instrument to be the free act and deed of said Municipality by it voluntarily executed.

Notary Public in and for the State of Iowa

[Signature page to Memorandum of Agreement– City of Ottumwa, Iowa]

CHRISTNER PROPERTIES, L.L.C.,
an Iowa limited liability company

By: _____

Print Name: _____

Its: _____

STATE OF IOWA)
) SS
COUNTY OF _____)

On this _____ day of _____, 2024, before me the undersigned, a Notary Public in and for said State, personally appeared _____ to me personally known, who, being by me duly sworn, did say that they are the _____ of Christner Properties, L.L.C., and that said instrument was signed on behalf of said limited liability company; and that the said officer acknowledged the execution of said instrument to be the voluntary act and deed of said limited liability company, by them voluntarily executed.

Notary Public in and for the State of Iowa

[Signature page to Memorandum of Agreement – Christner Properties, L.L.C.]

EXHIBIT D
DEVELOPER CERTIFICATION OF COSTS OF INFRASTRUCTURE IMPROVEMENTS

Christner Properties, L.L.C. (the "Developer") certifies that the expenses shown on the table below were/are the actual expenses incurred by the Developer for the Infrastructure Improvements that are the subject of a Development Agreement entered into as of _____, 2024 between the City of Ottumwa, Iowa and the Developer (the "Agreement").

Project Cost Category	Engineering, Plans, Specifications	Construction Costs	Legal Costs	Drainage, Landscaping, Grading	Interest during construction and for not more than six months thereafter	Miscellaneous
Invoice description and cost						
Invoice description and cost						
Invoice description and cost						
Invoice description and cost						
Total Cost per category						

If you need additional space please attach another table.

Attach actual receipts and invoices

Furthermore, Developer certifies that the total costs for construction of the Infrastructure Improvements did not exceed \$81,000.

I certify under penalty of perjury and pursuant to the laws of the State of Iowa that the preceding is true and correct to the best of my knowledge and belief.

CHRISTNER PROPERTIES, L.L.C.

By: _____

Print Name: _____

STATE OF IOWA, COUNTY OF _____) ss

On this _____ day of _____, 20____, before me the undersigned, a Notary Public in and for said State, personally appeared _____, who, being by me duly sworn, did say that they are _____ of Christner Properties, L.L.C., and that said instrument was signed on behalf of said limited liability company; and that the said officer as such, acknowledged the execution of said instrument to be the voluntary act and deed of said limited liability company, by them voluntarily executed.

 Notary Public in and for the State of Iowa



Overview

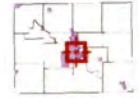

Legend

- Easements
- Lots
- Subdivisions
- City Limits
- Lot Symbols
- Misc Symbols
- Parcel Symbols
- Road Symbols
- Right-of-Way Line
- Roads
- Sections
- Section Center
- Quarter Lines
- Quarter Quarter Lines

Parcel ID	007411010031000	Alternate ID	n/a	Owner Address	Cabanas III LLC
Sec/Twp/Rng	0-0-0	Class	R		3412 Livingston Lane
Property Address	130 S IOWA	Acreage	n/a		Carrollton, TX 75007
	OTTUMWA				

District OTTUMWA CITY/ OTTUMWA SCH
 Brief Tax Description MANNING'S 2ND ADD
 LOT 31 BLK 1
 (130 S IOWA AVE)
 (Note: Not to be used on legal documents)

Date created: 12/29/2023
 Last Data Uploaded: 12/29/2023 6:05:34 AM